

# SILVERCREST®



[www.lidl-service.com](http://www.lidl-service.com)



## MICROONDE IN ACCIAIO SMW 900 EDS B2

IT MT

### MICROONDE IN ACCIAIO

Istruzioni per l'uso

DE AT CH

### EDELSTAHL-MIKROWELLE

Bedienungsanleitung

GB MT

### STAINLESS STEEL MICROWAVE

Operating instructions

IAN 96324

IT



IT MT

Prima di leggere aprire la pagina con le immagini e prendere confidenza con le diverse funzioni dell'apparecchio.

---

GB MT

Before reading, unfold the page containing the illustrations and familiarise yourself with all functions of the device.

---

DE AT CH

Klappen Sie vor dem Lesen die Seite mit den Abbildungen aus und machen Sie sich anschließend mit allen Funktionen des Gerätes vertraut.

IT / MT	Istruzioni per l'uso	Pagina	1
GB / MT	Operating instructions	Page	27
DE / AT / CH	Bedienungsanleitung	Seite	53

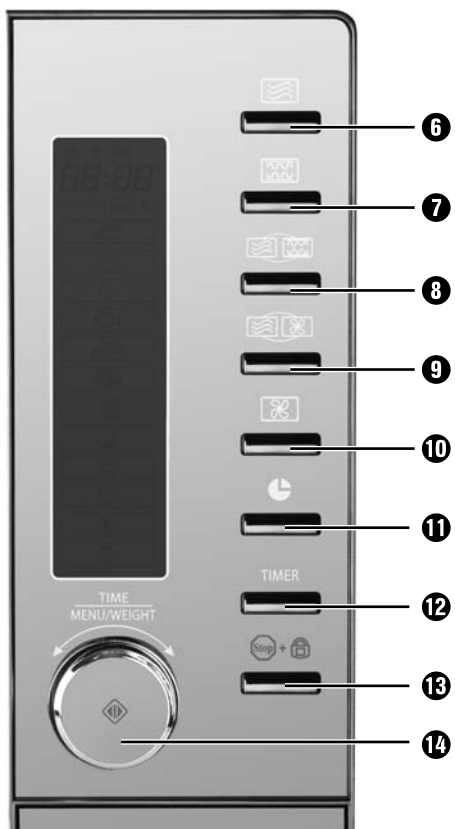
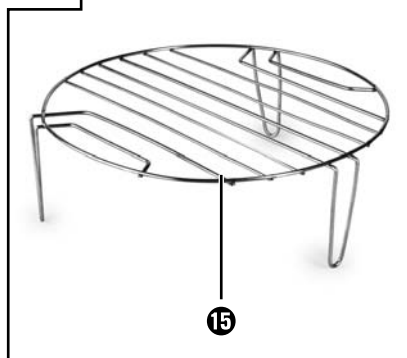
**A****B****C**

# INDICE

# PAGINA

<b>Introduzione</b>	<b>3</b>
<b>Uso conforme</b>	<b>3</b>
<b>Volume della fornitura</b>	<b>3</b>
<b>Descrizione dell'apparecchio</b>	<b>3</b>
<b>Dati tecnici</b>	<b>3</b>
<b>Importanti indicazioni di sicurezza</b>	<b>4</b>
<b>Prima di cominciare</b>	<b>10</b>
Principi basilari per la cottura a microonde.....	10
Uso delle stoviglie di cottura idonee .....	10
<b>Prima messa in funzione</b>	<b>11</b>
Installazione dell'apparecchio.....	11
Preparazione dell'apparecchio .....	11
Inserimento del piatto girevole 3.....	12
<b>Uso</b>	<b>12</b>
Impostazione dell'ora .....	12
Modalità Standby .....	12
Impostazione timer da cucina .....	12
Sicurezza bambini .....	13
Funzioni di interrogazione .....	13
Interruzione/arresto del procedimento di cottura o scongelamento.....	13
<b>Bollitura e cottura</b>	<b>13</b>
Modalità microonde .....	13
Funzione Grill .....	14
Combinazione procedimento di cottura "Grill" .....	15
Funzionamento ad aria calda .....	16
Funzionamento ad aria calda con preriscaldamento .....	17
Combinazione-procedimento di cottura "Aria calda".....	17
<b>Menu automatico</b>	<b>18</b>
Avvio del menu automatico .....	18
Cottura della pizza.....	21
<b>Scongelamento</b>	<b>21</b>
Scongelamento in base al peso.....	21
Scongelamento in base al tempo .....	22

---

<b>Ricette</b>	<b>23</b>
Polpette.....	23
Doratura di panini pronti surgelati .....	23
Patate gratinate .....	23
Muffin .....	24
<b>Pulizia e cura</b>	<b>24</b>
<b>Guasti e possibili rimedi</b>	<b>25</b>
<b>Smaltimento</b>	<b>26</b>
<b>Garanzia e assistenza</b>	<b>26</b>
<b>Importatore</b>	<b>26</b>

---

# Microonde in acciaio

## Introduzione

Congratulazioni per l'acquisto del nuovo apparecchio. È stato acquistato un prodotto di alta qualità. Il manuale di istruzioni è parte integrante del presente prodotto. Esso contiene importanti indicazioni per la sicurezza, l'uso e lo smaltimento. Prima di utilizzare il prodotto, familiarizzarsi con tutte le indicazioni relative ai comandi e alla sicurezza. Utilizzare il prodotto solo come descritto e per i campi d'impiego indicati. In caso di cessione del prodotto a terzi, consegnare anche tutta la documentazione relativa.

## Uso conforme

Questo apparecchio è previsto per il riscaldamento e la preparazione di alimenti secondo il procedimento prescritto.

Ogni modifica dell'apparecchio viene considerata non conforme alla destinazione e comporta considerevoli rischi d'infortunio. Il produttore non si assume alcuna responsabilità per i danni derivanti da uso non conforme.

Questo apparecchio è destinato esclusivamente all'uso domestico.

Esso non è destinato all'uso industriale, commerciale o nei laboratori!

## Volume della fornitura

Microonde in acciaio  
Piatto girevole  
Base grill  
Istruzioni per l'uso  
Brevi informazioni (2 pezzi)

## Descrizione dell'apparecchio

Figura A:

- 1 Display
- 2 Tasto Apertura porta
- 3 Piatto girevole
- 4 Rotelle
- 5 Feritoie di aerazione

Figura B:









- 6 Tasto Microonde 
- 7 Tasto Grill 
- 8 Tasto Combinazione microonde - grill 
- 9 Tasto Combinazione microonde - aria bollente 
- 10 Tasto Aria bollente 
- 11 Tasto Ora 
- 12 Tasto TIMER (timer cucina)
- 13 Tasto Stop/sicurezza bambini 
- 14 Regolatore / Tasto Start/avvio rapido 

Figura C:

- 15 Griglia

## Dati tecnici

Tensione nominale: 230 - 240 V ~, 50 Hz

Assorbimento di potenza massimo

Microonde: 1400 W

Grill: 1500 W

Aria bollente: 1950 W

Emissione massima di tensione

Microonde: 900 W +/- 10%

Frequenza microonde: 2450 - MHz

## Importanti indicazioni di sicurezza

---

Leggere attentamente le avvertenze di sicurezza prima del primo utilizzo e conservarle per il successivo impiego.

### **Attenzione!**

Avvertenze relative a eventuali danneggiamenti dell'apparecchio.

### **Pericolo!** / **Pericolo di lesioni!**

Avviso di pericolo di lesioni e scossa elettrica!

### **Pericolo d'incendio!**

Avviso di pericolo d'incendio.

### **Avvertenza!**

Suggerimenti e consigli per l'uso del forno a microonde.

## Misure di prevenzione per evitare un'esposizione eccessiva all'energia a microonde

- Non tentare di far funzionare l'apparecchio con lo sportello aperto, poiché il funzionamento con lo sportello aperto può dare luogo a un'esposizione alle microonde in quantità nociva per la salute. È inoltre importante non manomettere e non manipolare le chiusure di sicurezza.
- Non attaccare alcun oggetto fra il fronte dell'apparecchio e lo sportello e impedire il depositarsi dello sporco o di resti di detergente sulle superfici isolanti.

### **Pericolo di lesioni!**

- *In caso di danni allo sportello o alle guarnizioni dello sportello, smettere immediatamente di utilizzare il forno a microonde. Fare eseguire subito le riparazioni da personale specializzato qualificato.*
- *Non tentare mai di riparare l'apparecchio autonomamente. La rimozione dell'alloggiamento può liberare energia a microonde. Fare eseguire le riparazioni solo da personale specializzato qualificato.*
- *Questo apparecchio può essere utilizzato dai bambini a partire dall'età di 8 anni e da persone con capacità fisiche, sensoriali o mentali ridotte ovvero prive di esperienze e/o conoscenze in merito qualora siano sorvegliati o siano stati adeguatamente istruiti sull'uso sicuro dell'apparecchio e ne abbiano compreso i relativi rischi.*
- *I bambini non devono giocare con l'apparecchio.*
- *La pulizia e la manutenzione a cura dell'utente non devono essere eseguite dai bambini a meno che non abbiano almeno 8 anni e non vengano sorvegliati.*

- Tenere lontano dall'apparecchio i bambini di età inferiore agli 8 anni.
- Utilizzare questo apparecchio solo per l'uso conforme a quanto descritto nel presente manuale. In questo apparecchio, non utilizzare sostanze chimiche o vapori corrosivi. Questo forno a microonde è stato costruito specificamente per il riscaldamento, la cottura, la grigliatura o l'essiccamento di alimenti. Non è stato progettato per l'uso industriale o in laboratorio.
- Non utilizzare il forno a microonde in caso di danni alla spina/cavo di rete. Fare sostituire la spina/il cavo danneggiato da personale specializzato qualificato, per evitare rischi.
- Tenere i bambini lontano dallo sportello del microonde mentre esso è in funzione. Pericolo di ustioni!
- Non rimuovere assolutamente l'alloggiamento del microonde.
- Fare sostituire la lampadina all'interno del microonde solo da personale specializzato qualificato.
- Non toccare mai lo sportello del microonde, l'alloggiamento, le aperture di aerazione, gli accessori o le stoviglie subito dopo il procedimento di grill, combi o menu automatico. Tali parti sono soggette a surriscaldamento. Farle raffreddare prima di pulirle.
- Assicurarsi che la spina dell'apparecchio sia sempre facilmente raggiungibile, in modo da riuscire rapidamente a staccarla dalla presa di corrente in caso di emergenza.
- I portatori di pace-maker devono informarsi presso il medico di fiducia prima di cominciare a utilizzare un microonde, per conoscere gli eventuali pericoli collegati all'uso dell'apparecchio.
- Non lasciare mai il cavo appeso sul tavolo o sul piano di lavoro. I bambini potrebbero tirarlo.
- Dopo il riscaldamento di barattoli, buste di pop-corn ecc., aprire le confezioni tenendo sempre l'apertura lontana dal corpo. Il vapore in fuoriuscita può dare luogo a ustioni.
- Non collocarsi mai direttamente davanti al microonde mentre si apre lo sportello. Il vapore in fuoriuscita può dare luogo a ustioni.
- Non eseguire frittture nel forno a microonde. L'olio bollente può danneggiare gli elementi dell'apparecchio e gli utensili, oltre a provocare ustioni.
- Agitare o mescolare sempre i biberon o le bottigliette per bambini dopo averle riscaldate nel microonde! Il contenuto potrebbe essersi riscaldato in modo disomogeneo e il bambino potrebbe riportare ustioni. Controllare in ogni caso la temperatura prima di somministrare l'alimento al bambino!



- Non modificare il microonde.
- Le radiazioni a microonde sono pericolose! Fare eseguire i lavori di manutenzione o riparazione che prevedano la rimozione delle coperture di protezione dal contatto con i raggi a microonde solo da personale specializzato.
- Prima del consumo, controllare la temperatura, per evitare scottature che potrebbero dimostrarsi letali per i bambini piccoli. Gli utensili di cottura, a causa del calore rilasciato dagli alimenti riscaldati, potrebbero diventare bollenti ed essere maneggiabili solo con le presine. Controllare l'idoneità degli utensili di cottura all'uso con il forno a microonde.

 **Attenzione! Superficie bollente!**

### **Pericolo di lesioni!**

- Non lasciare il microonde incustodito mentre si riscaldano gli alimenti in confezioni di plastica o di carta.
- Non collocare materiali infiammabili nelle vicinanze del microonde o delle aperture di aerazione.
- Rimuovere tutte le chiusure metalliche dalle confezioni degli alimenti che si desiderano riscaldare. Pericolo di incendio!
- Per la preparazione di pop-corn, utilizzare solo buste di pop-corn idonee per il microonde.
- Non utilizzare il forno a microonde per riscaldare cuscini pieni di granaglie, noccioli di ciliegie o gel. Pericolo di incendio!
- Non utilizzare il microonde per depositare alimenti o altri oggetti.
- Non superare mai i tempi di cottura indicati dal produttore.
- Non collocare oggetti sul forno a microonde in funzione. Le aperture di aerazione verrebbero ostruite!
- Non collocare il microonde nelle vicinanze di altri apparecchi che emettono calore, come ad esempio forni.
- Pulire accuratamente il microonde dopo aver riscaldato cibi grassi, soprattutto se scoperchiati. Fare raffreddare completamente l'apparecchio prima di pulirlo. Rimuovere i residui, come ad es. il grasso, dalle resistenze del grill. I residui potrebbero surriscaldarsi e incendiarsi.
- Non scongelare oli o grassi surgelati nel microonde. Gli oli o i grassi potrebbero incendiarsi.
- Non utilizzare timer esterni o un sistema di telecomando separato per azionare l'apparecchio.

- Questo microonde destinato al riscaldamento di alimenti e bevande. L'asciugatura di alimenti o di indumenti e il riscaldamento di cuscini termici, pantofole, spugne, canovacci umidi o simile potrebbero causare lesioni, infiammazioni o incendio.

### **⚠️ *Attenzione! Danni all'apparecchio!***

- Non mettere mai in funzione il forno a microonde vuoto. L'unica eccezione a tale regola è costituita dalla prima messa in funzione (v. capitolo „Prima messa in funzione“).
- Non inserire oggetti nelle aperture di aerazione o nei blocchi di sicurezza dello sportello.
- Non utilizzare utensili metallici, che riflettono le microonde e possono provocare la formazione di scintille. Non collocare barattoli di metallo nel forno a microonde.
- Non inserire contenitori in plastica nel microonde subito dopo un procedimento di grill, combi o menu automatico. La plastica potrebbe sciogliersi.
- Il microonde non dev'essere collocato in luoghi ad alta umidità ambientale o concentrazione di umidità.
- Non riscaldare liquidi e altri alimenti in contenitori a tenuta stagna, poiché essi possono esplodere e danneggiare l'apparecchio.
- Non poggiarsi sullo sportello del microonde.
- La pulizia insufficiente dell'apparecchio di cottura può provocare la distruzione delle superfici, influenzando la durata di utilizzo e creando circostanze di pericolo.

### **⚠️ *Pericolo!***

- Non immergere mai il cavo o la spina in acqua o altri liquidi.
- Tenere il cavo lontano dalle fonti di calore. Non collocarlo davanti allo sportello del microonde. Il calore può danneggiare il cavo.
- Non versare mai liquidi nelle aperture di aerazione o nei blocchi di sicurezza dello sportello. In caso di penetrazione di liquidi, spegnere immediatamente il microonde e staccare subito la spina dalla presa. Fare controllare il microonde da personale specializzato qualificato.

## Consigli di sicurezza

- *Per minimizzare il rischio d'incendio nel forno a microonde: tenere sempre d'occhio il forno a microonde, se si riscaldano alimenti in contenitori di carta o plastica, per intervenire prima che si infiammino.*
- *Nel riscaldare bevande nel forno a microonde, si potrebbe verificare una bollitura ritardata. Manipolare il contenitore con cautela.*

*Per evitare bolliture improvvise:*

  - *Se possibile, inserire un bastoncino di vetro nel liquido durante il riscaldamento.*
  - *Dopo il riscaldamento, lasciare il liquido nel microonde per 20 secondi, per evitare schizzi imprevisti.*
- *Punzecchiare la buccia delle patate, la pelle delle salsicce e simili. In caso contrario, tali cibi potrebbero esplodere.*
- *Agire con cautela nel riscaldare i liquidi. Utilizzare solo contenitori aperti, in modo da permettere la fuoriuscita delle bolle d'aria.*
- *Se l'apparecchio rilascia fumo, spegnere l'apparecchio o staccare la spina e tenere chiuso lo sportello per soffocare eventuali fiamme.*
- *Le uova nel guscio e le uova sode non devono essere riscaldate nel forno a microonde, poiché possono esplodere anche dopo il termine del riscaldamento nel forno a microonde. Prima della cottura, punzecchiare gli alimenti con la buccia spessa, come ad esempio patate, zucche intere, mele e castagne.*
- *Non spostare il microonde mentre è in funzione.*

## **Messa a terra/installazione conforme**

Il presente apparecchio dev'essere provvisto di messa a terra. Questo apparecchio dev'essere collegato solo a una presa di corrente installata a norma e provvista di messa a terra. Si consiglia di utilizzare un circuito elettrico proprio, destinato ad alimentare unicamente il forno a microonde.

**⚠ Pericolo:** *l'uso non conforme della messa a terra può comportare il rischio di scossa elettrica.*

**ⓘ Avvertenza:** *in caso di domande relative alla messa a terra o a istruzioni riguardanti la parte elettrica, rivolgersi a un elettricista o manutentore.*

Né il produttore né il rivenditore si assumono responsabilità per danneggiamenti all'apparecchio o danni personali derivanti dal mancato rispetto delle indicazioni relative alla procedura di collegamento alla rete elettrica.

## **Interferenze con altri apparecchi**

L'uso del forno a microonde può dare luogo a interferenze con apparecchi radiofonici, televisivi e simili.

In caso di presenza di tali interferenze, è possibile ridurle o eliminarle, ricorrendo ai seguenti provvedimenti:

- Pulire lo sportello e le superfici isolanti.
- Orientare diversamente la radio o il televisore.
- Collocare il forno a microonde su un posto diverso da quello del ricevitore.
- Allontanare il forno a microonde dal ricevitore.
- Collegare il forno a microonde a un'altra presa di corrente. Il forno a microonde e il ricevitore dovrebbero utilizzare due diversi circuiti elettrici.

# Prima di cominciare

## Principi basilari per la cottura a microonde

- Disporre i cibi in modo appropriato.
- Collocare le parti più spesse ai bordi.
- Rispettare il tempo di cottura. Selezionare il tempo di cottura più breve e prolungarlo in caso di necessità. I cibi cotti troppo a lungo possono cominciare a emettere fumo o a bruciarsi.
- Durante la cottura, coprire i cibi con un coperchio idoneo per il forno a microonde. Il coperchio trattiene gli spruzzi e contribuisce a una cottura uniforme dei cibi.
- Durante la preparazione nel microonde, girare i cibi una volta, per permettere la cottura rapida di alimenti come polli o hamburger.
- Girare almeno una volta i pezzi di cibo più grandi, come ad esempio le costate.
- Trascorsa la prima metà del tempo di cottura, ridisporre i cibi, come ad esempio le polpette, in modo completamente diverso. Girarle e spostarle dal centro al margine.

## Uso delle stoviglie di cottura idonee

- Il materiale ideale per un forno a microonde è permeabile alle microonde, cioè permette il passaggio dell'energia attraverso il contenitore, per riscaldare i cibi.  
Le microonde non riescono a penetrare i metalli. Per tale motivo, non utilizzare recipienti e stoviglie in metallo.

- Per riscaldare i cibi nel forno a microonde non utilizzare prodotti a base di carta riciclata. Tali prodotti potrebbero contenere minuscoli frammenti metallici, in grado di produrre scintille e/o provocare incendi.
- Si consiglia di utilizzare stoviglie rotonde/ovalie invece che con spigoli/oblunghie, poiché i cibi cuociono troppo negli angoli.  
La seguente lista è da intendersi come una guida generale per la selezione delle stoviglie corrette.

Stoviglie di cottura	Microonde	Grill	Aria calda	Combinazione
Vetro resistente al calore	Sì	Sì	Sì	Sì
Vetro non resistente al calore	No	No	No	No
Ceramica resistente al calore	Sì	Sì	Sì	Sì
Posate in plastica idonee all'uso con forno a microonde	Sì	No	No	No
Carta da cucina	Sì	No	No	No
Vassoio /piatto in metallo	No	Sì	Sì	No
Base grill	No	Sì	Sì	No
Pellicola di alluminio & contenitore	No	Sì	Sì	No

## **⚠ Pericolo d'incendio!**

Non utilizzare mai la base grill o altri oggetti metallici se si usa il microonde in modalità microonde o procedimento combinato di cottura. Il metallo riflette la radiazione a microonde e provoca la formazione di scintille. Ciò può dare luogo a un incendio e danneggiare l'apparecchio irrimediabilmente!

## **Prima messa in funzione**

### **Installazione dell'apparecchio**

#### **⚠ Pericolo d'incendio!**

Questo microonde non è indicato per l'installazione in un mobile da cucina chiuso. Nei mobili chiusi non è garantita una sufficiente aerazione. L'apparecchio può essere danneggiato e sussiste il pericolo d'incendio!

- Selezionare una superficie piana che consenta uno spazio sufficiente per l'aerazione dell'apparecchio.  
È assolutamente necessario lasciare una distanza minima fra apparecchio e pareti di almeno 10 cm. Assicurarsi che lo sportello del forno si apra liberamente senza incontrare ostacoli. Al di sopra del forno a microonde dev'essere garantito uno spazio libero di almeno 20 cm.
- Provvedere a un collocamento accessibile della spina di rete, per poterla raggiungere e staccare facilmente in caso di pericolo.
- Non rimuovere i piedini di supporto situati sul lato inferiore del forno a microonde.
- Non bloccare le aperture di aerazione ⑤. In caso contrario, si possono verificare danni all'apparecchio.

- Collocare l'apparecchio il più possibile lontano da apparecchi radiofonici e televisivi. L'accensione del forno a microonde può dare luogo a interferenze nella ricezione dei segnali radiofonici e televisivi.

#### **⚠ Attenzione:**

non posizionare il forno a microonde su un fornello da cucina o su altri apparecchi che producono calore. Ciò può provocare danni all'apparecchio e conseguente estinzione della garanzia.

### **Preparazione dell'apparecchio**

- Rimuovere il materiale di imballaggio e la pellicola applicata sul pannello e sul tasto Apertura porta ②.









Non rimuovere la placca di copertura grigio-chiaro in mica, applicata per proteggere i tubi a campi magnetici nel vano di cottura.

- Inserire la spina in una presa di corrente. Utilizzare una presa di rete da 230 - 240 V ~, 50 Hz, con un fusibile da 16 A. Si consiglia di utilizzare un unico circuito destinato esclusivamente al microonde. Se non si è sicuri delle modalità di collegamento del microonde, affidarsi ai consigli di un esperto.

Prima dell'uso del microonde, è necessario riscaldare l'apparecchio a vuoto per vaporizzare i residui di lavorazione.

Dopo aver inserito la spina nella presa di rete, aprire una volta la porta del microonde premendo il tasto Apertura porta ②.

Accendere l'apparecchio senza alimenti e senza accessori (piatto girevole ③ e griglia ⑬) nella modalità Grill:

- Premere il tasto Grill **7** . Nel display compare "Gr 1".
- Ruotare il regolatore **14** , fino alla comparsa di "Gr 3" e dei simboli  e  nel display e confermare la selezione premendo sul tasto Start/avvio rapido **14** .
- Con il regolatore **14**  impostare un tempo di cottura di 10 minuti.
- Premere il tasto Start/avvio rapido **14** , per avviare il procedimento di grigliatura.

### **Avvertenza**

*durante la prima messa in funzione può verificarsi una leggera formazione di fumi e odori, dovuti ai resti di lavorazione del prodotto. Si tratta di un evento innocuo. Provvedere a una sufficiente aerazione. Aprire ad esempio una finestra.*

- Dopo 10 minuti l'apparecchio si spegne automaticamente. Attendere fino al suo completo raffreddamento.
- Staccare la spina dalla presa e quindi pulire l'apparecchio dall'interno con un panno umido e asciugarlo accuratamente.

### **Inserimento del piatto girevole **3****

- Collocare il piatto girevole **3** al centro sull'asse sul vano di cottura. Controllare che esso scivoli completamente sull'asse e sia posizionato saldamente.



## **Uso**

### **Impostazione dell'ora**

Dopo aver inserito la spina nella presa di rete, aprire una volta lo sportello del forno a microonde.





Il display **1** mostra "1:00". Richiudere lo sportello.

1. Premere il tasto Ora **11** . Nel display **1** compare "Hr 12".

2. Ruotando il regolatore **14**  selezionare la modalità desiderata (Hr 24 o Hr 12) e confermare la selezione premendo sul tasto Start/avvio rapido **14** .

### **Avvertenza**

*solo al termine della rotazione del regolatore **14**  compare l'indicazione dell'orario e si possono impostare le ore.*

3. Ruotando il regolatore **14**  selezionare l'ora desiderata e confermare la selezione premendo sul tasto Start/avvio rapido **14** .
  4. Ruotando il regolatore **14**  selezionare i minuti desiderati e confermare la selezione premendo sul tasto Start/avvio rapido **14** .
- Adesso l'ora è impostata.



Per leggere l'orario corrente mentre il microonde è in funzione, premere il tasto Orario **11** ; l'orario viene quindi visualizzato nel display **1** dopo qualche secondo.

### **Modalità Standby**

Il microonde passa automaticamente alla modalità Standby e viene visualizzato l'orario se per un periodo di tempo prolungato non viene premuto alcun tasto. Pochi secondi dopo il passaggio alla modalità Standby si smorza anche l'illuminazione del display.

### **Impostazione timer da cucina**

Il forno a microonde dispone di un timer di cottura utilizzabile indipendentemente dal forno a microonde.

1. Premere il tasto TIMER **12**, con l'apparecchio in standby. Nel display **1** compare "0:00" e il simbolo .
2. Impostare quindi il tempo desiderato con il regolatore **14**.   
Si possono eseguire impostazioni del tempo da un minimo di 10 secondi a un massimo di 95 minuti.







3. Premere il tasto Start/avvio rapido **14**  . Verrà emesso un segnale acustico. Il tempo scorre a ritroso. Dopo circa 3 secondi viene nuovamente visualizzato l'orario normale. Il timer da cucina continua a scorrere in sottofondo. Se nel frattempo si desidera controllare il tempo del timer da cucina, premere il tasto TIMER **12**. Comparirà per breve tempo il timer da cucina.

Non appena il tempo impostato scade risuoneranno dei segnali acustici.

## Sicurezza bambini

Attivare questa impostazione per evitare una messa in funzione involontaria del forno a microonde da parte di bambini o altre persone non autorizzate all'utilizzo del forno.

Il simbolo della sicurezza bambini  compare nel display **1**, e l'apparecchio non può essere messo in funzione fino a quando tale funzione resta attiva.

- Premere il tasto Stop/Sicurezza bambini **13**  +  e tenerlo premuto fino a quando non risuonerà un segnale acustico e non comparirà il simbolo Sicurezza bambini  nel display **1**. I tasti e il regolatore del microonde non hanno più alcuna funzione.
- Per disattivare la sicurezza bambini, premere il tasto Stop/Sicurezza bambini **13**  +  e tenerlo premuto fino a quando non risuonerà un segnale acustico e non scomparirà il simbolo Sicurezza bambini  nel display .

## Funzioni di interrogazione





### Richiesta dell'ora durante il funzionamento

Durante il procedimento di cottura, premere il tasto Ora **11**  . L'orario viene quindi visualizzato nel display **1** per qualche secondo.

### Richiesta del livello di potenza durante il funzionamento

Durante il procedimento di cottura, premere il tasto Microonde **6**  . Il livello di potenza attivato viene quindi visualizzato nel display **1** per qualche secondo.

## Interruzione/arresto del procedimento di cottura o scongelamento

- Premere una volta il tasto Stop **13**  +  , per interrompere il procedimento di cottura o scongelamento. L'apparecchio interrompe il procedimento e arresta il conto del tempo rimanente. Premere il tasto Start/avvio rapido **14**  , per riavviare il procedimento.
- Premere due volte il tasto Stop **13**  +  , per interrompere un procedimento di cottura. L'apparecchio ritorna alla modalità standby.

## Bollitura e cottura

### **Avvertenza**

*Questo microonde è provvisto di una funzione di raffreddamento: dopo un procedimento di cottura o grigliatura che duri almeno 2 minuti, la ventola dell'apparecchio funziona ancora per circa 3 minuti. Non si tratta di un malfunzionamento dell'apparecchio! Il raffreddamento più rapido aiuta a prolungare la durata di vita dell'apparecchio.*

## Modalità microonde

### **Avvertenza**



*Sulla porta del microonde o sull'alloggiamento, durante il procedimento di cottura, possono formarsi gocce d'acqua. Si tratta di un fenomeno normale, e non di un malfunzionamento del microonde. Asciugare l'umidità con un panno asciutto dopo aver atteso il raffreddamento del forno.*

### **Pericolo d'incendio!**

*Non utilizzare mai la base grill **15** o altri oggetti metallici se si usa il microonde in modalità microonde. Il metallo riflette la radiazione a microonde e provoca la formazione di scintille. Ciò può dare luogo a un incendio e danneggiare l'apparecchio irreparabilmente!*



## Selezione della potenza

1. Premere il tasto Microonde **6** . Nel display **1** compare "900" (potenza 900 Watt).
2. Con l'aiuto del regolatore **14**  impostare la potenza desiderata.
3. Premere il tasto Start/avvio rapido **14** , per confermare la potenza impostata.

## Impostazione del tempo di cottura



Dopo aver selezionato la potenza, impostare il tempo di cottura desiderato:

- Ruotare il regolatore **14**  fino a impostare il tempo di cottura desiderato.

## I livelli per il tempo di impostazione del regolatore **14** sono i seguenti:

- da 0 sec. a 5 min.: in passi di 10 sec.
- da 5 a 10 min.: in passi di 30 sec.
- da 10 a 30 min.: in passi di 1 min.
- da 30 a 95 min.: in passi di 5 min.

## Annullamento/termine del procedimento di immissione

Premere una volta il tasto Stop **15**  +  per interrompere o terminare un procedimento. L'apparecchio ritorna alla modalità standby.

## Avvio del procedimento di cottura



Se si è impostata la potenza e il tempo di cottura, si può avviare il procedimento:

Premere il tasto Start/avvio rapido **14**  per avviare il procedimento di cottura.

Nel display **1** compare il simbolo della modalità Microonde . Il tempo impostato scorre a ritroso.



Se il tempo impostato è scaduto, alla fine compaiono alternativamente i due messaggi "End" e "Hot" nel display **1**. Un segnale acustico risuona più volte consecutivamente.

## Avvio rapido 1

In modalità Standby ruotare il regolatore **14**  a destra e impostare la durata desiderata di cottura. Avviare il procedimento di cottura con una potenza di 900 W premendo il tasto Start/Avvio rapido **14** .

## Avvio rapido 2

Con questa funzione si può cominciare immediatamente la cottura per 30 secondi (o più a lungo, fino a 95 minuti) con potenza di 900 W.

- Premere il tasto Start/avvio rapido **14** . Nel display **1** compare il simbolo per la modalità Microonde , e "00:30". Il microonde avvia il procedimento di cottura per 30 secondi. Il tempo scorre a ritroso.

Se si desidera cuocere più a lungo di 30 secondi, premere il tasto Start/avvio rapido **14**  fino a ottenere il tempo di cottura desiderato.

I livelli di tempo si dividono come segue:

- da 30 sec. a 5 min.: in passi di 30 sec.
- da 5 min. a 95 min.: in passi di 1 min.

## Funzione Grill

### **Avvertenza**









*Per grigliare utilizzare sempre la base grill **15**. In tal modo si ottiene un risultato ottimale. Poggiare la base grill **15** sempre sul piatto girevole **3**.*





### **Pericolo d'incendio!**

*Utilizzando la funzione Grill, non utilizzare assolutamente coperchi o stoviglie non resistenti al calore, poiché essi potrebbero sciogliersi o causare un incendio!*

Sono a disposizione 3 funzioni Grill:

- Funzione Grill "Calore superiore" (Gr 1):  
con questa funzione il calore viene solo dall'alto. Solo il grill superiore è attivato. Pertanto tale funzione è ottimale per sandwich con copertura da gratinare e gratin.
- Funzione Grill "Calore inferiore" (Gr 2):  
con questa funzione il calore viene solo dal basso. Solo il grill inferiore è attivato. Pertanto questa funzione grill è adatta per ricette o alimenti che devono essere cotti o grigliati dal basso.
- Funzione Grill "Calore superiore e inferiore" (Gr 3):  
con questa funzione il calore proviene dal basso e dall'alto. Viene attivato il grill superiore e inferiore. Pertanto questa funzione Grill si può utilizzare per fette sottili di carne, bistecche, polpette, salsicce o pezzi di pollo.

1. Per grigliare premere il tasto Grill   una volta, al fine di attivare la funzione Grill. Nel display  compare il simbolo per la funzione Grill "Calore superiore"  e "Gr 1".
2. Impostare la funzione Grill desiderata con il regolatore  :  
"Gr 1" per il calore superiore,  
"Gr 2" per il calore inferiore,  
"Gr 3" per il calore superiore e inferiore.  
Confermare la selezione premendo il tasto Start/avvio rapido  .
3. Impostare quindi il tempo di cottura desiderato con il regolatore  . Il tempo di cottura massimo è pari a 95 minuti.
4. Premere il tasto Start/avvio rapido  per avviare la funzione Grill.

Nel display  compare il simbolo della modalità Grill  /  /  selezionata. Il tempo impostato scorre a ritroso. Se il tempo impostato è scaduto, alla fine compaiono alternativamente i due messaggi "End" e "Hot" nel display  . Un segnale acustico risuona più volte consecutivamente.

## Combinazione procedimento di cottura "Grill"

Questa funzione combina la funzione grill con il normale funzionamento a microonde. Durante il procedimento combinato, un determinato periodo di tempo viene utilizzato per la cottura, e il restante per la grigliatura, il tutto automaticamente e in un unico procedimento. Un leggero clic indica la commutazione dell'apparecchio da un procedimento all'altro.

### **Pericolo d'incendio!**

*Non utilizzare mai la base grill  o altri oggetti metallici se si usa il microonde in modalità procedimento di cottura combinato. Il metallo riflette la radiazione a microonde e provoca la formazione di scintille. Ciò può dare luogo a un incendio e danneggiare l'apparecchio irreparabilmente!*







*Utilizzando la funzione "Grill" con procedimento di cottura combinato, non utilizzare assolutamente coperchi o stoviglie non resistenti al calore, poiché essi potrebbero sciogliersi o causare un incendio!*



Sono a disposizione 4 combinazioni:

- Combinazione 1 (C 1):  
con la combinazione 1, la potenza del microonde viene usata per il 30% e la potenza del grill per il 70% del tempo di cottura. Tale combinazione è ad es. indicata per il pesce o piatti gratinati. Si utilizza la funzione microonde e la funzione grill "Calore superiore".
- Combinazione 2 (C 2):  
con la combinazione 2, la potenza del microonde viene usata per il 55% e la potenza del grill per il 45% del tempo di cottura. Tale combinazione è ad es. indicata per omelette, budini o lasagne. Si utilizza la funzione microonde e la funzione grill "Calore superiore".
- Combinazione 3 (C 3):  
con la combinazione 3, la potenza del microonde viene usata per il 30% e la potenza del grill per il 70% del tempo di cottura. Tale combinazione è indicata ad esempio per le patate. Si utilizza la funzione microonde e la funzione grill "Calore superiore e inferiore".

- **Combinazione 4 (C 4):**







Con la combinazione 4, la potenza del microonde viene usata per il 55% e la potenza del grill per il 45% del tempo di cottura. Tale combinazione è indicata ad esempio per ricette a base di pollame. Si utilizza la funzione microonde e la funzione grill "Calore superiore e inferiore".

1. Premere il tasto combinazione Microonde - Grill **8**  una volta, per attivare la combinazione 1 (C 1). Nel display **1** compare , , e "C 1".
2. Impostare la combinazione desiderata con il regolatore **14**   
"C 1" per la combinazione 1,  
"C 2" per la combinazione 2,  
"C 3" per la combinazione 3,  
"C 4" per la combinazione 4.  
Confermare la selezione premendo il tasto Start/avvio rapido **14** .
3. Impostare quindi il tempo di cottura desiderato con il regolatore **14** . Il tempo di cottura massimo è pari a 95 minuti.
4. Premere il tasto Start/avvio rapido **14**  per avviare il procedimento.

Sul display **1** compaiono i simboli dei procedimenti di cottura , , . Il tempo impostato scorre a ritroso. Se il tempo impostato è scaduto, alla fine compaiono alternativamente i due messaggi "End" e "Hot" nel display **1**. Un segnale acustico risuona più volte consecutivamente.

## Funzionamento ad aria calda











Nel corso della cottura con aria calda, l'aria calda circola nel vano di cottura. L'aria calda è particolarmente indicata per la preparazione di sfornati o alimenti croccanti. Si può impostare una temperatura da 110°C - 200°C per una durata massima di 95 minuti.



1. Premere il tasto Aria bollente **10** . Nel display compare "200C" (= 200°C) e il simbolo per la modalità Aria bollente .
2. Ruotando il regolatore **14**  selezionare la temperatura desiderata e confermare la selezione premendo il tasto Start/avvio rapido **14** .
3. Impostare quindi il tempo di cottura desiderato con il regolatore **14** .
4. Premere il tasto Start/avvio rapido **14**  per avviare il procedimento di cottura.

Nel display **1** compare il simbolo per la modalità Aria bollente . Il tempo impostato scorre a ritroso. Se il tempo impostato è scaduto, alla fine compaiono alternativamente i due messaggi "End" e "Hot" nel display **1**. Un segnale acustico risuona più volte consecutivamente.

## Funzionamento ad aria calda con preriscaldamento

Il microonde si può anche preriscaldare prima di avviare un procedimento di cottura:

1. Selezionare la temperatura desiderata premendo una volta il tasto Aria bollente  e impostare la temperatura con il regolatore . NON confermare questa impostazione premendo il tasto Start/avvio rapido .
2. Per avviare il preriscaldamento premere il tasto Aria bollente . Nel display  compare "30:00" e il simbolo per la modalità Aria bollente  lampeggia. Il tempo scorre a ritroso. Non appena viene raggiunta la temperatura impostata, risuonano dei segnali acustici e il tempo si ferma.
3. Aprire la porta e inserire l'alimento da cuocere.
4. Ruotando il regolatore  impostare la temperatura desiderata e confermare la temperatura premendo il tasto Start/avvio rapido .
5. Impostare quindi il tempo di cottura desiderato con il regolatore . Il tempo di cottura massimo è pari a 95 minuti.
6. Premere il tasto Start/avvio rapido  per avviare il procedimento.









Nel display  compare costantemente il simbolo per la modalità Aria bollente . Il tempo impostato scorre a ritroso. Se il tempo impostato è scaduto, alla fine compaiono alternativamente i due messaggi "End" e "Hot" nel display . Un segnale acustico risuona più volte consecutivamente.





## Combinazione-procedimento di cottura "Aria calda"

Questa funzione combina la funzione Aria calda con il normale funzionamento a microonde. In tal modo, ad esempio, la carne viene succosa, morbida e nel contempo croccante.

### **Pericolo d'incendio!**

*Non utilizzare mai la base grill  o altri oggetti metallici se si usa il microonde in modalità procedimento di cottura combinato. Il metallo riflette la radiazione a microonde e provoca la formazione di scintille. Ciò può dare luogo a un incendio e danneggiare l'apparecchio irreparabilmente!*

1. Premere il tasto combinazione Microonde - Aria bollente . Nel display  compare la temperatura preimpostata "200C" e i simboli  e .
2. Con l'aiuto del regolatore  selezionare la temperatura desiderata: 110°C, 140°C, 170°C o 200°C. Confermare la selezione premendo il tasto Start/avvio rapido .
3. Impostare quindi il tempo di cottura desiderato con il regolatore . Il tempo di cottura massimo è pari a 95 minuti. Confermare il tempo di cottura impostato premendo il tasto Start/avvio rapido .

La combinazione procedimento di cottura si avvia. Sul display  compaiono i simboli per la combinazione procedimento di cottura "Aria calda" , . Il tempo impostato scorre a ritroso. Se il tempo impostato è scaduto, alla fine compaiono alternativamente i due messaggi "End" e "Hot" nel display . Un segnale acustico risuona più volte consecutivamente.

## Menu automatico

Per gli alimenti preparati in modalità Menu automatico non è necessario impostare la durata del procedimento di cottura e il livello di potenza. È sufficiente inserire il tipo e il peso dell'alimento che si deve cuocere/bollire.



### **⚠ Pericolo d'incendio!**

Per i programmi con funzione grill attivata (A-01, A-02, A-03, A-04, A-05) non utilizzare assolutamente dei coperchi o stoviglie non resistenti al calore, poiché potrebbero sciogliersi o provocare un incendio!

### **i Avvertenza**

Il microonde calcola il tempo/il livello di potenza per gli alimenti freschi. Gli alimenti surgelati non cuociono con i tempi preindicati dal microonde (escluso il programma automatico "Pizza"). È necessario scongelare prima gli alimenti surgelati con il programma di scongelamento (v. capitolo "Scongelamento").

### Avvio del menu automatico





1. Ruotare lentamente a sinistra il regolatore **14**  (in modalità Standby) per richiamare la modalità Menu automatico. Nel display **1** compare un numero (ad es. "A - 02" per il programma automatico 2 (maiale)) e il simbolo "Maiale". Ruotando il regolatore **14**  selezionare il menu automatico per il proprio alimento.



### **i Avvertenza**

Se si è arrivati alla modalità Menu automatico tramite la rotazione a sinistra del regolatore **14** , ruotando a destra è possibile selezionare i menu automatici con la sequenza A01, A02, A03...

Di-play	Simbolo	Alimento	Peso
A-01		Manzo	200 - 1400 g
A-02		Maiale	200 - 1400 g
A-03		Pollame	400 - 1400 g
A-04		Pesce	200 - 1200 g
A-05		Pizza	*P1 150-450 g P2 150-450 g P3 150-450 g
A-06		Frutta/ verdura	100 - 1000 g
A-07		Patate	100 - 800 g
A-08		Riscaldamento	300 - 700 g
A-09		Bevande	200 - 500 ml
A-10		Antipasti	300 - 500 g
A-11		Scongela- mento in base al peso	-
A-12		Scongela- mento in base al tempo	-





\* Per ulteriori informazioni sui programmi Pizza leggere il capitolo "Cottura della pizza".



2. Confermare la selezione premendo il tasto Start/avvio rapido  .
3. Impostare il peso con l'aiuto del regolatore  e confermarlo premendo il tasto Start/avvio rapido  . Il procedimento di cottura viene avviato e il tempo raggiunto scorre a ritroso.

Il procedimento di cottura si avvia. Sul display compaiono i simboli delle funzioni di cottura e di cottura alla griglia che vengono utilizzati per il programma automatico scelto: funzione microonde , funzione grill Calore superiore , funzione grill Calore inferiore . Il tempo calcolato procede alla rovescia.

### **Avvertenza**

Per ottenere una cottura uniforme, è necessario girare alcuni cibi a 2/3 del tempo di cottura. Il microonde si ferma automaticamente allo scadere del tempo, risuonano 4 segnali acustici e nel display  compare "Turn".

Di- splay	Simbolo	Alimento	girare dopo...
A-01		Manzo	2/3 del tempo
A-02		Maiale	2/3 del tempo
A-03		Pollame	2/3 del tempo
A-04		Pesce	2/3 del tempo



- Girare gli alimenti. Procedere con cautela con le vivande che potrebbero essere bollenti.
- Premere il tasto Start/avvio rapido  , per riavviare il procedimento di cottura.





### **Avvertenza**



Se non si vogliono girare gli alimenti, attendere la cessazione dei segnali acustici. L'apparecchio prosegue il procedimento di cottura automaticamente. Consigliamo di girare comunque i cibi. In tal modo si ottiene una cottura uniforme.

### **Avvertenz**

Se la vivanda non si è cotta correttamente al termine del Menu automatico, continuare a cuocerla come segue:

- Utilizzare il procedimento di cottura indicato nella tabella. Avviarlo per qualche minuto e controllare il risultato.
- Per la continuazione della cottura di una pizza con l'ausilio del Menu automatico "P2" interrompere il procedimento di cottura premendo il tasto Stop/sicurezza bambini  + , non appena la pizza si è cotta a sufficienza.

Di- splay	Simbolo	Alimento	Cottura finale con...
A-01		Manzo	Combinazione procedimento di cottura "Grill" - C3
A-02		Maiale	Combinazione procedimento di cottura "Grill" - C3
A-03		Pollame	Combinazione procedimento di cottura "Grill" - C3
A-04		Pesce	Combinazione procedimento di cottura "Grill" - C3
A-05		Pizza	Menu auto- matico "Pizza" - P2

A-06		Frutta/ verdura	Funzionamento microonde con 900 W di potenza
A-07		Patate	Funzionamento microonde con 900 W di potenza
A-08		Riscalda- mento	Funzionamento microonde con 900 W di potenza
A-09		Bevande	Funzionamento microonde con 900 W di potenza
A-10		Antipasti	Funzionamento microonde con 900 W di potenza
A-11		Scongela- mento in base al peso	Funzionamento microonde con 100 W di potenza
A-12		Scongela- mento in base al tempo	Funzionamento microonde con 100 W di potenza

### **Pericolo di lesioni!**









Il piatto girevole  è bollente dopo il procedimento di cottura con il grill! Utilizzare pertanto sempre presine o guanti resistenti al calore per prelevarlo dal vano di cottura.

### **Avvertenza**

Ricordare che le dimensioni, la forma e i tipi di alimenti contribuiscono al risultato di cottura.









### **Esempio di impiego 1:**

procedere come segue, se si desidera cuocere 400 g di verdura o frutta:

1. Ruotare il regolatore   (in modalità Standby) lentamente a sinistra fino alla comparsa di "A-06" nel display  e confermare la selezione premendo il tasto Start/avvio rapido  .
2. Impostare quindi il peso "400" con il regolatore  .
3. Premere il tasto Start/avvio rapido  , per avviare il procedimento di cottura.







### **Esempio di impiego 2:**

procedere come segue, se si desidera riscaldare 300 ml di acqua:

1. Ruotare il regolatore   (in modalità Standby) lentamente a sinistra fino alla comparsa di "A-09" nel display  e confermare la selezione premendo il tasto Start/avvio rapido  .
2. Impostare quindi il peso "300" con il regolatore  .
3. Premere il tasto Start/avvio rapido  , per avviare il procedimento di cottura.







### **Esempio di impiego 3:**

procedere come segue, se si desidera riscaldare 300 g di antipasto:

1. Ruotare il regolatore   (in modalità Standby) lentamente a sinistra fino alla comparsa di "A-10" nel display  e confermare la selezione premendo il tasto Start/avvio rapido  .
2. Quando compare "300" come prima selezione, premere il tasto Start/avvio rapido  , per avviare il procedimento di cottura.

## Cottura della pizza

Con il programma automatico "Pizza" si possono preparare croccanti pizze nel forno a microonde. Qui è possibile selezionare fra i programmi per la cottura della pizza "P-01" (pizza surgelata), "P-02" (pizza refrigerata) e "P-03" (pizza fresca).



1. Ruotare lentamente a sinistra il regolatore **14**  (in modalità Standby) fino a ottenere nel display **1** il messaggio "A-05".
2. Premere il tasto Start/avvio rapido **14** .
3. Con l'aiuto del regolatore **14**  selezionare il programma adatto per la cottura della pizza:
  - "P-01" per la pizza surgelata, temperatura ca. -18 gradi peso 150 g - 450 g (nel display **1** compare "P-01").
  - "P-02" per la pizza refrigerata, temperatura ca. 5 gradi peso 150 g - 450 g (nel display **1** compare "P-02").
  - "P-03" per la pizza fresca, temperatura ca. 20 gradi peso 150 g - 450 g (nel display **1** compare "P-03").
4. Confermare la selezione premendo il tasto Start/avvio rapido **14** .
5. Selezionare il peso desiderato con il regolatore **14**  e confermarlo premendo il tasto Start/avvio rapido **14** . Il procedimento di cottura si avvia.



### **Avvertenza**

Se si prepara la pizza, è possibile collocarla direttamente sul piatto rotante **3**. In tal modo sarà particolarmente croccante. Assicurarsi che i bordi della pizza non tocchino le pareti del vano di cottura durante il procedimento di cottura.

### Esempio di impiego:

procedere come segue, se si desidera cuocere una pizza surgelata da 450 g:

1. Ruotare lentamente a sinistra il regolatore **14**  (in modalità Standby) fino a ottenere nel display **1** il messaggio "A-05".
2. Premere il tasto Start/avvio rapido **14** .
3. Con l'aiuto del regolatore **14**  selezionare il programma "P-01".

4. Premere il tasto Start/avvio rapido  **14**.
5. Selezionare il peso "450" con il regolatore **14** .
6. Premere il tasto Start/avvio rapido **14** , per avviare il procedimento di cottura. L'apparecchio calcola automaticamente il tempo necessario.





## Scongellamento

### Scongellamento in base al peso

#### **Avvertenza**

collocare i cibi da scongelare sempre su stoviglie idonee per il microonde, mai direttamente sul piatto girevole **3**!

Con questa funzione si può scongelare senza problemi la carne, il pollame, il pesce, la frutta/verdura e la pizza. Il tempo di scongelamento e il livello di potenza vengono calcolati e impostati automaticamente inserendo il peso.

1. In modalità Standby ruotare il regolatore **14**  in senso antiorario, fino alla comparsa nel display **1** del messaggio lampeggiante "A-11"  (vedere il capitolo "Menu automatico").
2. Premere il tasto Start/avvio rapido  **14**.
3. Ruotando il regolatore **14**  selezionare l'alimento da scongelare. Nel display **1** compare:

"d-01" e  per "Manzo"

"d-02" e  per "Maiale"

"d-03" e  per "Pollame"



"d-04" e  per "Pesce"

"d-05" e  per "Pizza"





"d-06" e  per "Frutta/verdura"

"d-07" e  per "Patate"

- Quando nel display ❶ compare l'alimento desiderato, premere il tasto Start/avvio rapido ❶ .
- Impostare quindi il peso ruotando il regolatore ❶ .

Si possono impostare i seguenti pesi:

"d-01" /  / "Manzo" 100 - 1800 g

"d-02" /  / "Maiale" 100 - 1800 g

"d-03" /  / "Pollame" 100 - 1800 g

"d-04" /  / "Pesce" 100 - 1800 g

"d-05" /  / "Pizza" 100 - 900 g

"d-06" /  / "Frutta/verdura" 100 - 900 g

"d-07" /  / "Patate" 100 - 900 g

- Quando il peso desiderato compare nel display ❶, premere il tasto Start/avvio rapido ❶ . L'apparecchio calcola automaticamente il peso di scongelamento necessario.

### **Avvertenza:**





per garantire uno scongelamento ottimale, è necessario girare gli alimenti durante il procedimento di scongelamento. L'apparecchio emette dei segnali acustici per ricordare che è necessario girare gli alimenti e sul display ❶ compare la scritta "turn". Aprire lo sportello dell'apparecchio, girare l'alimento e richiudere lo sportello dell'apparecchio. Premere il tasto Start/avvio rapido ❶ , per proseguire il procedimento di scongelamento.

Se non si vogliono girare gli alimenti, attendere la cessazione dei segnali acustici. L'apparecchio prosegue il procedimento di scongelamento automaticamente. Consigliamo di girare comunque i cibi. In tal modo si ottiene uno scongelamento uniforme.

## Scongelamento in base al tempo

### **Avvertenza:**

collocare i cibi da scongelare sempre su stoviglie idonee per il microonde, mai direttamente sul piatto girevole ❸!

- Per lo scongelamento, in modalità Standby ruotare il regolatore ❶  in senso antiorario, fino alla comparsa nel display ❶ del messaggio "A -12" e .
- Premere il tasto Start/avvio rapido  ❶.
- Impostare quindi il tempo desiderato con il regolatore ❶ .
- Premere il tasto Start/avvio rapido ❶ , per avviare il procedimento di scongelamento. Il tempo scorre a ritroso.

### **Avvertenza:**

per garantire uno scongelamento ottimale, è necessario girare gli alimenti durante il procedimento di scongelamento. L'apparecchio emette dei segnali acustici per ricordare che è necessario girare gli alimenti e sul display ❶ compare la scritta "turn". Aprire lo sportello dell'apparecchio, girare l'alimento e richiudere lo sportello dell'apparecchio. Premere il tasto Start/avvio rapido ❶ , per proseguire il procedimento di scongelamento.

Se non si vogliono girare gli alimenti, attendere la cessazione dei segnali acustici. L'apparecchio prosegue il procedimento di scongelamento automaticamente. Consigliamo di girare comunque i cibi. In tal modo si ottiene uno scongelamento uniforme.

## Ricette

---

### Polpette

- Creare ogni polpetta con circa 125 g di carne tritata di manzo (diametro circa 75 mm, altezza ca. 35 mm).
- Distribuire le polpette uniformemente sul piatto girevole ❸.

### Preparazione

Il migliore risultato si ottiene utilizzando alternativamente la funzione Aria bollente e la funzione Microonde. Attendere che sia terminato ogni volta il procedimento di cottura impostato e quindi avviare il procedimento successivo.

1. Aria bollente 200° C, 4:00 min.
2. Microonde 900 W di potenza, 5:30 min.
3. Aria bollente 200° C, 2:00 min. (in base ai gusti personali, si può scegliere anche un tempo massimo di 4:00 min.).

### Doratura di panini pronti surgelati

- Per la cottura di panini selezionare la funzione Aria bollente.
- Collocare 3-4 panini sul piatto girevole ❸.

Non è necessario preriscaldare il microonde.

Selezionare la seguente impostazione per il procedimento di cottura:

- Aria bollente 170° C, durata: 12 minuti

Se si desidera continuare con la doratura di altri panini, ridurre il tempo di circa 1-2 minuti, poiché l'apparecchio è già preriscaldato.

### Patate gratinate

#### Ingredienti

- 750 g di patate pelate a pasta gialla
- 300 g di panna
- 100 g di formaggio grattugiato con contenuto di grasso compreso fra il 25% e il 30% nella massa secca.
- Spezie a piacere (ad es. sale/pepe)

Utilizzare un tegame rotondo idoneo all'uso nel microonde, con coperchio, con un'altezza di 5 - 6 cm e un diametro di circa 22 cm.

#### Preparazione

- Tagliare le patate in fette spesse circa 3 - 4 mm.
- Collocare circa la metà delle patate nello stampo.
- Ricoprire le patate con circa la metà del formaggio.
- Aggiungere la metà delle spezie e circa 150 g di panna.
- Collocare il resto delle patate tagliate al di sopra.
- Distribuire il resto del formaggio sulle patate e versarvi su il resto della panna.
- Cospargere il gratin con il resto delle spezie.
- Coprire il tegame con il coperchio e collocarlo centralmente sul piatto girevole ❸.

#### Preparazione

Il migliore risultato si ottiene utilizzando alternativamente la funzione Aria bollente e la funzione Microonde. Attendere che sia terminato ogni volta il procedimento di cottura impostato e quindi avviare il procedimento successivo.

1. Microonde 900 W di potenza, 10:00 min.
2. Aria bollente 200° C, 13:00 min.
3. Microonde 900 W di potenza, 10:00 min.

Non è necessario preriscaldare il microonde.

## Muffin

### Ingredienti

La ricetta produce circa 10 - 20 muffin.

- Margarina per panificazione (80% di contenuto di grassi) o burro salato
- 170 g zucchero semolato (granulazione max. 0,3 mm)
- 3 uova (55 - 60 g con guscio/dimensione M)
- 225 g farina di frumento
- 7 g polvere lievitante
- 0,25 g di sale

### Preparazione

- Mescolare bene tutti gli ingredienti.
- Versare l'impasto per muffin nelle apposite formine di carta reperibili in commercio (diametro circa 45 mm, altezza ca. 28 mm)
- Riscaldare il microonde con la funzione Aria calda a 170° C.

#### **Avviso:**

*se fossero necessari vari procedimenti di cottura a causa del numero di muffin, il preriscaldamento è necessario solo la prima volta.*

- Distribuire quindi uniformemente i muffin sul piatto girevole .
- Selezionare la seguente impostazione per il procedimento di cottura:  
Aria calda 170° C, durata: 12 minuti

## Pulizia e cura

### **Pericolo di lesioni!**

*Prima di pulire il forno a microonde, spegnerlo e disconnetterlo dalla presa di corrente. In caso contrario sussiste il rischio di scossa elettrica!*

 Non immergere assolutamente l'apparecchio in acqua o altri liquidi! Potrebbe derivarne pericolo di morte a causa di scosse elettriche e l'apparecchio potrebbe subire danni.

- Tenere sempre pulito l'interno del forno a microonde.
- Rimuovere con un panno inumidito le pareti imbrattate da spruzzi o da liquidi versati.
- Utilizzare un detergente delicato in caso di sporco resistente nel forno a microonde.
- Evitare l'utilizzo di spray detergenti e di altri utensili di pulizia acuminati, che potrebbero creare macchie, striature o opacizzare la superficie dello sportello.
- Pulire le pareti esterne con un panno umido.
- Per evitare il danneggiamento dei componenti funzionali all'interno del forno a microonde, impedire la penetrazione di acqua nelle aperture di aerazione .
- Rimuovere regolarmente gli spruzzi o la sporcizia. Ripulire lo sportello, la finestra di ispezione da entrambi i lati, le guarnizioni e le parti circostanti con un panno inumidito. Non utilizzare agenti abrasivi.

- Se sulla superficie all'interno o all'esterno dello sportello si formasse del vapore, asciugarlo con un panno morbido. Ciò si verifica se il forno a microonde viene fatto funzionare in presenza di forte umidità.
- Pulire regolarmente anche il piatto girevole ❸. Lavare il piatto in una soluzione di acqua calda e sapone.
- Pulire la base grill ❶ in acqua saponata calda e farla asciugare bene.
- Eliminare regolarmente gli odori. A tal fine, posizionare nel forno una ciotola profonda adatta al forno a microonde, riempita con una tazza di acqua, il succo e la buccia di un limone. Riscaldare per 5 minuti. Pulire a fondo e asciugare con un panno morbido.
- Se dovesse rendersi necessaria la sostituzione della lampadina del forno a microonde, farla sostituire dal rivenditore o dai nostri centri di assistenza autorizzati.

## Guasti e possibili rimedi

---

### Il display ❶ non mostra niente.

- La spina di rete non è inserita nella presa. Controllare la spina.
- La presa di rete è guasta. Provare a utilizzare un'altra presa di rete.
- Il display ❶ è difettoso. Contattare il centro di assistenza.

### L'apparecchio non reagisce alla pressione dei tasti.

- La protezione bambini è attivata. Disattivare la protezione bambini (v. capitolo „Uso“).

### L'apparecchio non avvia il procedimento di cottura.

- Lo sportello non è chiuso correttamente. Chiudere lo sportello correttamente.

### Il piatto girevole ❸ fa rumore mentre ruota.

- Il piatto girevole ❸ non è collocato correttamente sull'asse. Collocare correttamente il piatto girevole ❸ nel vano di cottura.
- Le rotelle ❹ e/o il fondo del vano di cottura sono sporchi. Pulire le rotelle ❹ e il fondo del vano di cottura.

### Il display ❶ mostra "E01" e risuonano dei segnali acustici.

- Il microonde è surriscaldato. Interrompere immediatamente il programma in corso. Staccare la spina di rete, aprire lo sportello del microonde e fare raffreddare l'apparecchio.

### Il display ❶ mostra "E02" e risuonano dei segnali acustici.

- Si è verificato un errore del sensore. Interrompere il programma e fare raffreddare l'apparecchio. Riavviare quindi il microonde. Se l'errore si verificasse nuovamente, rivolgersi al servizio clienti.
- Si è verificato un errore nel riscaldamento dell'apparecchio. Interrompere il programma e fare raffreddare l'apparecchio. Riavviare quindi il microonde. Se l'errore si verificasse nuovamente, rivolgersi al servizio clienti.

### Il display ❶ mostra "E03" e risuonano dei segnali acustici.

- Il microonde è passato alla funzione di protezione dai guasti a causa di un cortocircuito o di una caduta di tensione. Interrompere il programma e staccare la spina dalla presa di corrente. Se possibile, rimuovere il problema, ad es. metallo nel vano di cottura, che può aver provocato l'errore sopra indicato durante l'uso della funzione microonde. Altrimenti rivolgersi all'assistenza clienti.

## Smaltimento

---



**Non smaltire per alcun motivo l'apparecchio insieme ai normali rifiuti domestici. Questo prodotto è soggetto alla Direttiva Europea 2012/19/EU.**

Smaltire l'apparecchio attraverso un'azienda di smaltimento autorizzata o attraverso l'ente di smaltimento comunale.

Rispettare le prescrizioni attualmente in vigore. In caso di dubbi mettersi in contatto con l'ente di smaltimento competente.



Smaltire tutti i materiali dell'imballaggio in modo ecocompatibile.

## Garanzia e assistenza

---

Questo apparecchio è garantito per tre anni a partire dalla data di acquisto. L'apparecchio è stato prodotto con cura e debitamente collaudato prima della consegna.

Conservare lo scontrino come prova d'acquisto. In caso di interventi in garanzia, contattare telefonicamente il proprio centro di assistenza. Solo in questo modo è possibile garantire una spedizione gratuita della merce.

La garanzia vale solo per i difetti di materiale o fabbricazione, non per i danni da trasporto, parti soggette a usura o danni a parti fragili come ad es. interruttori o accumulatori. Il prodotto è destinato esclusivamente all'uso domestico e non a quello commerciale.

La garanzia decade in caso di impiego improprio o manomissione, uso della forza e interventi non eseguiti dalla nostra filiale di assistenza autorizzata.

Questa garanzia non costituisce alcun limite ai diritti legali del consumatore. Il periodo di garanzia non viene prolungato in caso di un intervento in garanzia. Ciò vale anche per le componenti sostituite e riparate. I danni e difetti presenti già all'acquisto devono essere comunicati immediatamente dopo il disimballaggio, e non oltre due giorni dalla data di acquisto. Le riparazioni effettuate dopo la scadenza del periodo di garanzia sono a pagamento.

### **IT Assistenza Italia**

Tel.: 02 36003201

E-Mail: [kompennass@lidl.it](mailto:kompennass@lidl.it)

**IAN 96324**

### **MT Assistenza Malta**

Tel.: 80062230

E-Mail: [kompennass@lidl.com.mt](mailto:kompennass@lidl.com.mt)

**IAN 96324**

### **Raggiungibilità della hotline:**

dal lunedì al venerdì, dalle 8.00 alle 20.00 (CET)

## Importatore

---

KOMPENASS HANDELS GMBH  
BURGSTRASSE 21  
44867 BOCHUM  
GERMANY  
[www.kompennass.com](http://www.kompennass.com)

<b>INDEX</b>	<b>PAGE</b>
<b>Introduction</b>	<b>29</b>
<b>Intended Usage</b>	<b>29</b>
<b>Scope of delivery</b>	<b>29</b>
<b>Appliance description</b>	<b>29</b>
<b>Technical details</b>	<b>29</b>
<b>Important safety instructions</b>	<b>30</b>
<b>Before you begin</b>	<b>36</b>
Basic principles of microwave cookery .....	36
Use suitable cookware .....	36
<b>Commissioning</b>	<b>37</b>
Installation of the appliance .....	37
Preparing the appliance.....	37
Place the turntable 3 inside .....	38
<b>Operation</b>	<b>38</b>
Setting the Clock.....	38
Standby mode .....	38
Setting the kitchen timer .....	38
Child lock.....	39
Query functions.....	39
Interrupt/cancel cooking or defrosting processes.....	39
<b>Heating and cooking</b>	<b>39</b>
Microwave operation .....	39
Grill function .....	40
Combination cooking process "Grill".....	41
Convection operation .....	42
Convection operation with preheating .....	43
Combination cooking process "Convection" .....	43
<b>Auto menu</b>	<b>44</b>
Starting the Auto menu.....	44
Baking pizza .....	46
<b>Defrosting</b>	<b>47</b>
Defrosting by weight.....	47
Defrosting by time .....	48

---

<b>Recipes</b>	<b>49</b>
Meat patty .....	49
Baking frozen ready-made bread rolls .....	49
Potato gratin .....	49
Muffins .....	50
<b>Cleaning and Care</b>	<b>50</b>
<b>Troubleshooting</b>	<b>51</b>
<b>Disposal</b>	<b>52</b>
<b>Warranty and Service</b>	<b>52</b>
<b>Importer</b>	<b>52</b>

---

# Stainless Steel Microwave

---

## Introduction

---

Congratulations on the purchase of your new appliance.

You have decided to purchase a high-quality product. The operating instructions are a constituent of this product. They contain important information regarding safety, use and disposal. Before using the product, familiarise yourself with all operating and safety instructions. Use this appliance only as described and only for the specified areas of application.

Please also pass these operating instructions on to any future owner(s).

## Intended Usage

---

This appliance is intended for the heating up and preparation of foods in accordance with the described procedures.

Any modification to the appliance shall be deemed to be improper use and entails considerable accident hazards. The manufacturer accepts no responsibility for damages arising from usage contrary to the instructions specified below.

This appliance is intended exclusively for use in domestic households!

Do not use it in/for commercial, industrial or laboratory areas/applications!

## Scope of delivery

---

Stainless Steel Microwave  
Turntable  
Grill stand  
Operating instructions  
Concise information (2 no.)

## Appliance description

---

Figure A:

- 1 Display
- 2 Door opener button
- 3 Turntable
- 4 Rollers
- 5 Ventilation slot

Figure B:







- 6 Microwave button 
- 7 Grill button 
- 8 Combination microwave - grill button 
- 9 Combination microwave - convection button 
- 10 Convection button 
- 11 Clock button 
- 12 TIMER button (kitchen timer)
- 13 Stop/child lock button 
- 14 Rotary knob / Start/quick start button 

Figure C:

- 15 Grill stands

## Technical details

---

Nominal voltage: 230 - 240 V ~,  
50 Hz

Maximum power consumption

Microwave: 1400 W

Grill: 1500 W

Convection: 1950 W

Maximum power delivery

Microwave: 900 W +/- 10%

Microwave frequency: 2450 MHz



# Important safety instructions

---

Carefully read these safety and operating instructions before the first use and preserve them for future reference.

## **Important!**

Warnings regarding damage to the appliance.

## **Danger!** / **Risk of injury!**

Warning about physical injuries and electric shock!

## **Risk of fire!**

Warning about risks of fire.

## **Notice!**

Note - Hints and tips for using the microwave.

## Safety precautions for the avoidance of excessive contact with microwave energy

- Do not try to operate the appliance while the door is open, as this can lead to you coming into contact with a potentially harmful dose of microwave radiation. It is also important not to break open or manipulate the safety locks .
- Do not jam anything between the front of the appliance and the door, and make sure that there is no residual food or cleaning agent on the seals.

## **Risk of injury!**

- *If the door or the door seal is damaged, under no circumstances may you continue to use the appliance. Arrange for it to be repaired as soon as possible by qualified specialists.*
- *Never attempt to repair the appliance yourself. Removal of the appliance housing could cause the release of microwave energy. Arrange for the repair to be carried out only by qualified specialists.*
- *This appliance may be used by children of the age of 8 years or more and by persons with reduced physical, sensory or mental capabilities or lack of experience and/or knowledge if they are supervised or have been instructed how to use the appliance safely and have understood the potential risks.*
- *Children must not play with the appliance.*
- *Cleaning and user maintenance tasks should not be carried out by children, unless they are at least 8 years old or more and are constantly supervised.*

- Children younger than 8 years of age are to be kept away from the appliance and the power cable.
  - Only use this appliance for its intended purpose as described in this manual. Do not use any caustic chemicals or vapours in this appliance. This micro-wave oven is especially designed for heating, cooking, grilling, or drying foodstuffs. It is not intended for use in industrial applications or laboratories.
  - Do not operate the microwave oven if the power cable or plug are damaged. To avoid injury, arrange for damaged power cables or plugs to be exchanged by qualified specialists before re-using the appliance.
  - Keep children well away from the microwave oven when it is in use.
- Risk of Burns!*
- Under no circumstances should you remove the microwave oven housing.
  - Should the lamp in the interior of the microwave oven need replacing, arrange for this to be done by a qualified specialist.
  - Never touch the microwave oven door, housing, ventilation openings, accessories or the dinnerware directly after the grill, combi or automatic menu process. The parts will be very hot. Allow them to cool down before cleaning them.
  - Ensure that the plug is at all times easily accessible, so that it can be quickly removed in the event of an emergency.
  - People fitted with a heart pacemaker should consult their doctor about the possible risks of using a microwave oven before taking one into use.
  - Do not allow the power cable to hang from a table or work surface. Children could pull on it.
  - After they have been warmed up, always open containers, popcorn-bags etc. with the opening pointing away from your body. Escaping steam could lead to scalds.
  - Never stand directly against the microwave oven when opening the door. Escaping steam could lead to scalds.
  - Do not fry in the microwave. Hot oil can damage parts of the appliance and utensils and even cause skin burns.
  - Always shake-up or stir warmed up baby glasses or bottles! The contents could have heated up unevenly and the baby could be burned/scalded by them. At all events, check their temperature before feeding them to the baby!
  - Do not modify the microwave oven.

- *Microwave radiation is dangerous! Maintenance and repairs requiring the removal of access covers, which are intended for protection against contact with microwave radiation, are to be carried out by trained specialists only.*
- *Before consumption, check the temperature, so as to avoid a potentially life-threatening scalding for babies.*  
Cooking utensils may become hot from the heat emitted by the food, so that you may require oven gloves to touch them. In this case, a check should also be made to ensure that the cooking utensils are suitable for use with the microwave oven.

 **Attention! Hot surfaces!**

 **Risk of fire!**

- *Never leave the microwave oven unattended if you are heating foodstuffs packed in plastics or paper.*
- *Never place flammable materials close to the microwave oven or the ventilation openings.*
- *Remove ALL metallic closures from the packaging of the foodstuff that you intend to warm up. Risk of fire!*
- *When making popcorn, use only popcorn-bags suitable for microwave ovens.*
- *Do not use the microwave oven to warm up cushions filled with kernels, cherry stones or gels. Risk of fire!*
- *Do not use the microwave oven for storing foodstuffs or other objects.*
- *Do not exceed the cooking times detailed by the manufacturer.*
- *Do not place any objects on the microwave oven when it is in use. The ventilation openings would be blocked!*
- *Do not place the microwave oven adjacent to other appliances discharging heat, for example, an oven.*
- *Clean the microwave oven thoroughly after warming up greasy foods, especially if they were not covered. Allow the appliance to cool down completely before cleaning it. Residues such as fat or grease cannot be allowed to collect on the heating elements of the grill. They could possibly ignite.*
- *Do not thaw frozen fat or oil in the microwave oven. The fat or oil could ignite.*
- *Do not use an external timing switch or a separate remote control system to operate the appliance.*

- This microwave is designed to be used for heating foods and drinks. Drying foods or clothing or the warming of heating pads, slippers, sponges, damp cloths or similar can lead to injuries, ignition of the material or fires.

### **⚠ Important! Appliance Damage!**

- Do not use the microwave oven when it is empty. The only exception is for the initial commissioning (see chapter "Commissioning").
- Never insert foreign objects into the ventilation openings or the door safety locks.
- Do not use metallic utensils which reflect microwaves and lead to sparking. Do not place tins in the microwave oven.
- Do not place plastic containers in the microwave oven immediately after a grill, combi or automatic menu process. The plastic could melt.
- This microwave oven may not be located in areas with high humidity or where moisture could collect.
- Liquids and other foods must not be heated in airtight containers, as these may explode and damage the appliance.
- Do not lean on the microwave oven door.
- Insufficient cleanliness of the appliance could lead to the destruction of the upper surfaces, which themselves influence its useful lifespan and could possibly also lead to dangerous situations.

### **⚠ Danger!**



- Never submerge the appliance, the power cable or the plug in water or other fluids.
- Keep the power cable away from hot surfaces. Do not lead it in front of the appliance door. The heat could damage the cable.
- Never pour fluids into the ventilation openings or the safety locks. Should fluids ever enter them, immediately switch the appliance off and remove the plug from the mains power socket. Arrange for the appliance to be checked by qualified specialists.

## Safety tips

- *To minimize the risk of fire in the appliance: When heating food in plastic or paper containers, always keep an eye on the appliance when it is in operation, as these materials can catch fire.*
- *When heating drinks in the appliance, bubbling may be delayed when the drink boils. Therefore, be careful when handling the container.*  
*To avoid sudden simmering:*
  - *If possible, place a glass rod in the fluid for as long as it is being heated.*
  - *To avoid an unexpected reboiling, leave the fluid to stand in the appliance oven for ca. 20 seconds after being warmed up.*
- *Puncture the skins of potatoes, sausages or similar. Otherwise, they could explode.*
- *Proceed with caution when warming up fluids. Use only open containers, so that any air bubbles produced can escape.*
- *If the appliance starts to give off smoke it should be switched off immediately or the plug removed from the mains and the door should be kept closed to smother any flames that might otherwise escape.*
- *Eggs in their shells and hard-boiled eggs should not be heated in the appliance as they could explode, even on completion of the heating process. Food with thick skins, such as potatoes, whole pumpkins, apples and chestnuts must be pricked before cooking.*
- *Do not transport the appliance when it is in use.*

## Earthing information/correct installation

This appliance must be earthed. This appliance is to be connected only to a correctly earthed power socket. An individual circuit, solely for the connection of the appliance, is recommended.

-  **Danger:** *Improper use of the earthing connector could increase the risk of an electric shock.*
-  **Notice:** *Should you have any questions about earthing or about the instructions on the use of this electrical appliance given here, please consult an electrician or a maintenance technician.*

Neither the manufacturer nor the dealer can accept liability for damage to the appliance or injury to persons resulting from failure to comply with the instructions for electrical connection.

## Interference with other appliances

The operation of the appliance may cause interference on your radio, television or similar appliances.

If such interference should occur, they may be reduced or corrected by the following remedial measures:

- Clean the door and the seal of the appliance.
- Re-align the receiver antenna of your radio or television.
- Position the appliance in a different place to the receiver.
- Move the appliance away from the receiver.
- Plug the appliance into another wall socket. The appliance and the receiver should be connected to different circuits.

## Before you begin

---

### Basic principles of microwave cookery

- Arrange the food with consideration.
- The thickest parts near the edges.
- Pay attention to the cooking time. Select the shortest possible stated cooking time and increase as required. Food that is cooked too long can begin to smoke or catch fire.
- Cover the food during cooking with a lid suitable for microwave cookery. The lid prevents splashing and helps in the even cooking of the food.
- While cooking, turn the food in the microwave once so that items such as chicken or hamburgers are cooked more quickly.
- Large pieces of food, such as joints of meat, must be turned at least once.
- Completely re-arrange foods such as meatballs after half the cooking time. Turn them and move the meatballs from the middle of the cookware to the edge.

### Use suitable cookware

- The ideal material for a microwave oven is microwave-permeable, allowing the energy to penetrate the container to heat the food. Microwaves cannot permeate metal. For this reason metal containers and cookware may not be used.

- When using the microwave for heating do not use products made of recycled paper. These can contain minute fragments of metal, which can generate sparks and/or fires.
- We recommend the use of round/oval cookware instead of square or oblong containers, as food in corner areas tends to overcook. The following list provides general hints to assist you in selecting the correct cookware.

Cookware	Micro-wave oven	Grill	Con-vection	Combi-nation
Heat-resistant glass	Yes	Yes	Yes	Yes
Non-heat-resistant glass	No	No	No	No
Heat-resistant ceramics	Yes	Yes	Yes	Yes
Plastic crockery suitable for microwave	Yes	No	No	No
Kitchen roll	Yes	No	No	No
Metal tray/plate	No	Yes	Yes	No
Grill stand	No	Yes	Yes	No
Alufoil & Foil containers	No	Yes	Yes	No

## **Risk of fire!**

NEVER use the grill stand or other metallic objects when you are using the appliance in the microwave mode or in the combination cooking process.

Metals reflect the microwave radiation and it leads to the generation of sparks. This could cause a fire and irreparably damage the appliance!

## Commissioning

---

### Installation of the appliance

#### **Risk of fire!**

This microwave oven is not suitable for installation in a kitchen cabinet. In closed cabinets sufficient ventilation for the appliance cannot be assured. The appliance could be damaged and there would be the additional risk of a fire!

- Select an even surface offering sufficient space for the adequate ventilation of the appliance: Ensure that you maintain a minimum distance of 10 cm from neighbouring walls/surfaces. Make sure that the door of the microwave oven can be opened easily. Maintain a gap of at least 20 cm above the microwave oven.
- Ensure that the electrical plug is accessible without problem, so that in case of danger it can be easily reached and removed.
- Do not remove the pads underneath the microwave oven.
- Do not block the ventilation openings . If you do, it could cause damage to the appliance.

- Install the appliance as far away as possible from radios and televisions. The operation of the microwave oven can cause malfunctions of radio and television reception.

#### **Warning:**

Do not install the microwave above a cooker or any other appliance generating heat. Installation at such a location could cause damage to the appliance and thereby a subsequent lapse of the warranty provisions.

### Preparing the appliance

- Remove the packaging material and the protective film applied to the panel and the door opener button .





Do not remove the light grey flimmer cover plate, which is mounted in the cooking compartment to protect the magnetron.







- Insert the plug into a mains power socket. Use a 230 - 240 V ~, 50 Hz, mains power socket with a 16 A fuse. We recommend that the microwave is powered by its own mains circuit. If you are unsure about how to connect the microwave oven, consult a specialist.

Before the first regular usage of the microwave oven the appliance must be heated up to remove any remaining production residues.

Once you have plugged the plug into the socket, open the microwave door once by pressing the Door opener button .

Switch the appliance on in grill operating mode without foods and without accessories (turntable  and grill stands 



- Press the Grill button **7** . "Gr 1" will appear in the display.
- Turn the rotary knob **14** , as far as "Gr 3" and the  and  symbols appear in the display, then confirm the selection by pressing the Start/quick start button **14** .
- Use the rotary knob **14**  to set a cooking time of 10 minutes.
- Press the Start/quick start button **14**  to start the grill process.

### **Note**

Light smoke generation and a slight smell can occur on first usage, this is due to production residues. These are not harmful. Provide sufficient ventilation. For example, open a window.

- After 10 minutes the appliance will switch itself off automatically. Wait until it has cooled down completely.
- Remove the plug from the mains power socket then, after cleaning the appliance with a moist cloth, dry it carefully.

### **Place the turntable **3** inside**

- Place the turntable **3** centrally over the axle in the cooking compartment. Ensure that it slides completely onto the axle and is firmly seated.



## **Operation**

---

### **Setting the Clock**





After inserting the mains plug into the socket, open the microwave door once. The display **1** shows "1:00". Re-close the door.

1. Press the Clock button **11** . "Hr 12" appears in the display **1**.

2. Select the required mode (Hr 24 or Hr 12) by turning the rotary knob **14**  and then confirm your selection by pressing the Start/quick start button **14** .

### **Note**

The time display will only appear once you turn the rotary knob  **14** again, which enables you to set the hour.

3. Select the required hour by turning the rotary knob **14**  and confirm your selection by pressing the Start/quick start button **14** .
  4. Select the required minutes by turning the rotary knob **14**  and confirm your selection by pressing the Start/quick start button **14** .
- The time display is now programmed.



To read the current time while the microwave is in operation, press the Clock button **11** ; the time is then shown in the display **1** for a few seconds.

### **Standby mode**

The microwave automatically switches over to standby mode, and the time is displayed, if no button is pressed for a longer period. The display illumination also dims a few seconds after switching over to standby mode.

### **Setting the kitchen timer**

The microwave oven is provided with a kitchen timer which you can use independently of the microwave operation.

1. Press the TIMER button **12** while the appliance is in standby mode. "0:00" is shown in the display **1** along with symbol .
2. Now set the required time using the rotary knob **14** . You can select any time range from 10 seconds to 95 minutes.







3. Press the Start/quick start button **14**  . The appliance emits an acoustic signal. The countdown begins. After approx. 3 seconds the current time is shown once again. The kitchen timer will continue to run in the background. If you want to check the kitchen timer inbetween times, press the TIMER button **12** . The kitchen timer appears for a moment.

As soon as the set time period has expired, signal tones sound.

## Child lock

Engage this setting to prevent accidental activation by children and other persons not familiar with the operation of the appliance.

The symbol for the child lock  appears in the display **1** , which means that the appliance cannot be operated as long as this function is activated.

- Press the Stop/child lock button **15**  +  and hold it down until a signal tone is sounded and the symbol for the child lock  appears in the display **1** . The buttons and the control dial now no longer have a function.
- To deactivate the child lock, press the Stop/child lock button **15**  +  and hold it down until a signal tone is sounded and the symbol for the child lock  goes out.

## Query functions





### Query the time during operation

During the cooking process, press the Clock button **11**  . The time will appear for a few seconds in the display **1** .

### Query the power level operation

During the cooking process, press the Microwave button **6**  . The activated power level will appear for a few seconds in the display **1** .

## Interrupt/cancel cooking or defrosting processes

- Press the Stop button **15**  +  , once in order to interrupt a cooking or defrosting process. The appliance interrupts the process and stops countdown of the remaining time. Press the Start/quick start button **14**  to continue the process.
- Press the Stop button **15**  +  twice to cancel a cooking process. The appliance reverts to standby mode.

## Heating and cooking

---

### Note

*This microwave is equipped with a cooling function. This means that the machine fan continues running for about 3 minutes after a cooking or grill process which takes at least two minutes. This is not a malfunction of the appliance! The rapid cooling helps to prolong the life of the appliance.*

## Microwave operation



### Note

*During the cooking process, drops of water can form on the oven door or on the housing. This is normal and is not an indication of a malfunction. When the appliance has cooled down, wipe the moisture off with a dry cloth.*

### Fire hazard!

*NEVER use the grill stand **15** or other metallic objects when you are using the appliance in the microwave mode. Metals reflect the microwave radiation and it leads to the generation of sparks. This could cause a fire and irreparably damage the appliance!*

## Selecting the operation level

1. Press the Microwave button **6** . "900" (900 W power) appears in the display **1**.
2. Now set the required power level using the rotary knob **14** .
3. Press the Start/quick start button **14**  to confirm the power level you have set.

## Programming the cooking time



After you have selected the power level, programme in the desired cooking time:

- Turn the rotary knob **14**  until the required cooking time has been set.

## The stages for the rotary knob **14** setting times are as follows:



- from 0 sec to 5 min: in 10 second increments
- from 5 to 10 min: in 30 second increments
- from 10 to 30 min: in 1 minute increments
- from 30 to 95 min: in 5 minute increments

## Aborting/stopping an input process

Press the Stop button **15**  +  once to cancel and exit an input process. The appliance reverts to standby mode.



## Starting the cooking process

When you have set the power and cooking time, you can start the cooking process:

Press the Start/quick start button **14**  to start the cooking process. The symbol for microwave operation  appears in the display **1**. The set time will now count down backwards. Once the set time has expired, "End" and "Hot" are shown alternating in the display **1**.



A signal tone is heard repeatedly.

## Quick start 1

When in standby mode, turn the rotary knob **14**  to the right and set the required cooking period. Start the cooking process with 900 W power by pressing the Start/quick start button **14** .

## Quick start 2

You can use this function to start cooking immediately for 30 seconds (or longer, up to 95 min) at 900 W power.

- Press the Start/quick start button **14**  once. The symbol for microwave operation  appears in the display **1** in addition to "00:30". The microwave starts the cooking process for 30 seconds. The countdown begins.

If you want to cook for longer than 30 seconds, press the Start/quick start button **14**  several times until the required time has been set.

The time levels are apportioned as follows:

- from 30 sec to 5 min: in 30 second increments
- from 5 min to 95 min: in 1 minute increments

## Grill function

### **Note**







Always use the grill stands **15** when grilling. This achieves an optimal grilling result. Always placed the grill stands **15** on the turntable **3**.



### **Fire hazard!**

When using the grill functions, under no circumstances should you use any form of covering or cookware that is not heat-resistant, as these could melt or ignite themselves!

3 grill functions are available:

- "Top heat" grill function (Gr 1):  
With this function, the heat only comes from above. Only the top grill is activated. This grill function is therefore suitable for grilled sandwiches and gratins.
- "Bottom heat" grill function (Gr 2):  
With this function, the heat only comes from below. Only the bottom grill is activated. This grill function is therefore suitable for meals or foods which need to be cooked or grilled from below.
- "Top and bottom heat" grill function (Gr 3):  
With this function, the heat comes from above and below. The top and the bottom grills are activated. This grill function is therefore suitable for thin slices of meat, steaks, hamburgers, sausages or chicken pieces.

1. Press the Grill button **7**  once to activate the grill function.  
The symbol for the "Top heat" grill function appears in the display **1**  along with "Gr 1".
2. Now set the required grill function using the rotary knob **14** :  
"Gr 1" for top heat,  
"Gr 2" for bottom heat,  
"Gr 3" for top and bottom heat.  
Confirm your selection by pressing the Start/quick start button **14** .
3. Now set the required cooking time using the rotary knob **14** . The maximum possible cooking time setting is 95 minutes.
4. To start grill function, press the Start/quick start button **14** .

The symbol for the selected grill function  /  /  appears in the display **1**. The set time will now count down backwards. Once the set time has expired, "End" and "Hot" are shown alternating in the display **1**. A signal tone is heard repeatedly.

## Combination cooking process "Grill"

This function combines the grill function and the normal microwave operation. During the combination mode, a certain amount of time for cooking and the remaining time for grilling is carried out automatically and in one process. You may notice a quiet clicking noise when the oven is switching between modes.

### **Fire hazard!**

*Never use the grill stand **15** or other metallic objects when you are using the microwave for combined cooking processes. Metals reflect the microwave radiation and it leads to the generation of sparks. This could cause a fire and irreparably damage the appliance!*









*When using the "Grill" combined cooking functions, under no circumstances should you use any form of covering or cookware that is not heat-resistant, as these could melt or ignite themselves!*





4 combinations are available:

- Combination 1 (C 1):  
For Combination 1, the microwave power is 30% and the grill power is 70% of the cooking time. This is suitable for fish or gratins, for example. The microwave function and the grill function "top heat" are used.
- Combination 2 (C 2):  
For Combination 2, the microwave power is 55% and the grill power is 45% of the cooking time. This is suitable for puddings, omelets or lasagne, for example. The microwave function and the "top heat" grill function are used.
- Combination 3 (C 3):  
For Combination 3, the microwave power is 30% and the grill power is 70% of the cooking time. This is suitable for potatoes, for example. The microwave function and the grill functions "top and bottom heat" are used.

- Combination 4 (C 4):







For Combination 4, the microwave power is 55% and the grill power is 45% of the cooking time. This is suitable for poultry dishes, for example. The microwave function and the grill functions "top and bottom heat" are used.



1. Press the Combination microwave-grill button  once to activate Combination 1 (C 1). , , and "C 1" are shown in the display .
2. Now set the required combination using the rotary knob  :  
 "C 1" for combination 1,  
 "C 2" for combination 2,  
 "C 3" for combination 3,  
 "C 4" for combination 4.  
 Confirm your selection by pressing the Start/quick start button .
3. Now set the required cooking time using the rotary knob . The maximum possible cooking time setting is 95 minutes.
4. Press the Start/quick start button  to start the process.

The symbols of the cooking process being used , ,  appear on the screen . The programmed time counts backwards. Once the set time has expired, "End" and "Hot" are shown alternating in the display . A signal tone is heard repeatedly.

## Convection operation











When cooking with convection, hot air circulates in the cooking compartment. Convection is especially recommended for cooking souffles or crunchy foods. You can set a temperature of between 110 °C and 200 °C and a duration of max. 95 min.



1. Press the Convection button . "200C" (= 200 °C) appears in the display along with the symbol for convection operation .
2. Use the rotary knob  to set the required temperature and confirm your selection by pressing the Start/quick start button .
3. Now set the required cooking time using the rotary knob .
4. Press the Start/quick start button  to start the cooking process.

The symbol for convection operation  appears in the display . The programmed time counts backwards. Once the set time has expired, "End" and "Hot" are shown alternating in the display . A signal tone is heard repeatedly.

## Convection operation with preheating

You can also preheat your microwave before you start a cooking process:

1. Select the required temperature by pressing the Convection button  and use the rotary knob  to set the temperature. You do NOT need to confirm this setting by pressing the Start/quick start button .
2. To start preheating, press the Convection button . "30:00" appears in the display  and the symbol for convection operation  flashes. The countdown begins. Assumes the set temperature is reached, signal tones will sound and the time will stop.
3. Open the door and place the foods to be cooked inside.
4. Turn the rotary knob  to set the temperature and confirm the temperature by pressing the Start/quick start button .
5. Now set the required cooking time using the rotary knob . The maximum possible cooking time setting is 95 minutes.
6. Press the Start/quick start button  to start the process.









The symbol for convection operation  appears in the display  permanently. The programmed time counts backwards. Once the set time has expired, "End" and "Hot" are shown alternating in the display . A signal tone is heard repeatedly.





## Combination cooking process "Convection"

This function combines the convection function with the normal microwave operation. With this, for example, meat is juicy and tender but still crisp.

### **Fire hazard!**

*Never use the grill stand  or other metallic objects when you are using the microwave for combined cooking processes. Metals reflect the microwave radiation and it leads to the generation of sparks. This could cause a fire and irreparably damage the appliance!*

1. Press the Combination microwave-convection button . The preset temperature "200C" and the symbols  and  appear in the display .
2. Now set the required temperature using the rotary knob  : 110°C, 140°C, 170°C or 200°C. Confirm your selection by pressing the Start/quick start button .
3. Now set the required cooking time using the rotary knob . The maximum cooking time is 95 minutes. Press the Start/quick start button  to confirm the set cooking time.

The combination process starts. The symbols for the combination cooking process "Convection" ,  appear on the screen . The programmed time counts backwards. Once the set time has expired, "End" and "Hot" are shown alternating in the display . A signal tone is heard repeatedly.

## Auto menu

For foods to be prepared in automatic menu mode, it is not necessary to enter the cooking time or power setting. It is quite sufficient to enter which type of food is to be cooked/boiled, and its weight.

### **Fire hazard!**





Under NO circumstances may you use covers or non-heat-resistant dishes for programmes with enabled Grill function (A-01, A-02, A-03, A-04, A-05), as they can melt or catch fire!

### **Note**



The microwave will calculate the time/power level for **fresh** foods. Deep-frozen foods will not be cooked properly using the times specified by the microwave (with the exception of the "Pizza" automatic programme).













If needs be, defrost frozen foods with the defrost programme beforehand (see section "Defrosting").

## Starting the Auto menu

1. Turn the rotary knob   (in standby mode) slowly to the left to call up the automatic menu mode. A number (e.g. "A - 02" for automatic programme 2 (pork)) and the "Pork" symbol appear in the display . Turn the rotary knob   to select the appropriate automatic menu for your food.

### **Note**



If you have entered automatic menu mode by turning the rotary knob   to the left, you can turn the rotary knob to the right afterwards to select the automatic menus in the sequence of A01, A02, A03... .

Display	Symbol	Food	Weight
A-01		Beef	200 - 1400 g
A-02		Pork	200 - 1400 g
A-03		Poultry	400 - 1400 g
A-04		Fish	200 - 1200 g
A-05		Pizza	*P1 150-450 g P2 150-450 g P3 150-450 g
A-06		Fruit/ vegetables	100 - 1000 g
A-07		Potatoes	100 - 800 g
A-08		Warming	300 - 700 g
A-09		Beverages	200 - 500 ml
A-10		Entrees	300 / 500 g
A-11		Defrosting by weight	-
A-12		Defrosting by time	-

\*Please refer to the chapter entitled "Baking pizzas" for more information on the pizza programme.

- Confirm your selection by pressing the Start/quick start button **13** .
- Turn the rotary knob **14**  to set the weight, and then confirm this by pressing the Start/quick start button **13** .





The cooking process is started and the calculated time will countdown backwards.

The cooking process starts. The symbols for the cooking and grill functions that are being used for the selected automatic programme appear on the display. Microwave function , grill function Top heat , grill function Bottom heat .

The calculated time starts running down.

### **Note**

To obtain uniform warming or cooking, some foods should be turned after 2/3 of the cooking process duration. The microwave automatically stops after this time, 4 signal tones sound and "Turn" appears in the display **1**.

Display	Symbol	Food	Turn over after...
A-01		Beef	2/3 of the time
A-02		Pork	2/3 of the time
A-03		Poultry	2/3 of the time
A-04		Fish	2/3 of the time



- Turn the food over. Proceed cautiously with food which may already be hot.
- Press the Start/quick start button **13**  to continue the cooking process.







### **Note**

If you do not want to turn the food, just wait for the signal tones to stop. The appliance will automatically continue the cooking process. We recommend that you do turn the food. This will ensure even cooking.







### **Note**

If the meal is not completely cooked after the automatic menu has finished, proceed as follows:

- Use the cooking process stated in the table for re-cooking. Start this process for a few minutes, and check the cooking result.
- When re-cooking a pizza using automatic menu "P2", interrupt the cooking process by pressing the Stop/child lock button  +  as soon as the pizza has been cooked enough.

Display	Symbol	Food	Re-cook with ...
A-01		Beef	"Grill" combination cooking process - C 3
A-02		Pork	"Grill" combination cooking process - C 3
A-03		Poultry	"Grill" combination cooking process - C 3
A-04		Fish	"Grill" combination cooking process - C 3
A-05		Pizza	"Pizza" automatic menu - P2
A-06		Fruit/vegetables	Microwave operation with 900 W power



A-07		Potatoes	Microwave operation with 900 W power
A-08		Warming	Microwave operation with 900 W power
A-09		Beverages	Microwave operation with 900 W power
A-10		Entrees	Microwave operation with 900 W power
A-11		Defrosting by weight	Microwave operation with 100 W power
A-12		Defrosting by time	Microwave operation with 100 W power

### Risk of injury!





The turntable  is always very hot after a cooking process using the grill! You should therefore always use an oven cloth or heat-resistant oven gloves when removing it from the cooking compartment.

### Note

Please note that the size, shape and the type of food-stuff determines the result of the cooking process.

### Example 1:





Proceed as follows to cook 400 g vegetables or fruit:

1. Turn the rotary knob  to the left (when in standby mode) until "A-06" appears in the display  and then confirm your selection by pressing the Start/quick start button .
2. Now set a weight of "400" using the rotary knob .

3. Press the Start/quick start button  to start the cooking process.





### Example 2:

To heat 300 ml water, proceed as follows:

1. Turn the rotary knob  to the left (when in standby mode) until "A-09" appears in the display  and then confirm your selection by pressing the Start/quick start button .
2. Now set a weight of "300" using the rotary knob .
3. Press the Start/quick start button  to start the cooking process.





### Example 3:



To heat 300 g of appetizers, proceed as follows:

1. Turn the rotary knob  to the left (when in standby mode) until "A-10" appears in the display  and then confirm your selection by pressing the Start/quick start button .
2. Since "300" is always the first selection in the display, press the Start/quick start button  to start the cooking process.

## Baking pizza

With the automatic programme "Pizza" you can prepare delicious pizzas in the microwave. In this case you can select between pizza programmes "P-01" (deep-frozen pizza), "P-02" (refrigerated pizza) and "P-03" (fresh pizza).

1. Turn the rotary knob  slowly to the left (when in standby mode) until "A-05" appears in the display .
2. Press the Start/quick start button .
3. Now set the required pizza programme using the rotary knob .







- "P-01" for deep-frozen pizza, temperature approx. -18°, weight 150g – 450g ("P-01" appears in the display ❶).
  - "P-02" for refrigerated pizza, temperature approx. 5°, weight 150g – 450g ("P-02" appears in the display ❶).
  - "P-03" for fresh pizza, temperature approx. 20°, weight 150g – 450g ("P-03" appears in the display ❶).
4. Confirm your selection by pressing the Start/quick start button ❶ .
  5. Turn the rotary knob ❶  to set the required weight, and then confirm this by pressing the Start/quick start button ❶ .
- The cooking process starts.

### Note

If you are cooking pizza, you can place this directly on the turntable ❸. It will be very crispy. Ensure that the edge of the pizza does not extend up to the walls of the cooking compartment during cooking.

### Example:

Proceed as follows to cook a deep-frozen pizza weighing 450 g:

1. Turn the rotary knob ❶  slowly to the left (when in standby mode) until "A-05" appears in the display ❶.
2. Press the Start/quick start button ❶ .
3. Now set the programme "P-01" using the rotary knob ❶ .
4. Press the Start/quick start button ❶ .
5. Now set a weight of "450" using the rotary knob ❶ .
6. Press the Start/quick start button ❶  to start the cooking process. The appliance calculates the time required automatically.





## Defrosting

### Defrosting by weight

#### Note

Always place the food to be defrosted on dishes suitable for use in a microwave oven. Never place it directly on the turntable ❸!

You can use this function to defrost. The defrosting time and the power level are calculated and set automatically once you have entered the weight.

1. When in standby mode, turn the rotary knob ❶  anticlockwise until "A-11" appears in the display ❶ and  flashes (see chapter "Automatic menu").
2. Press the Start/quick start button ❶ .
3. Now select the food to be defrosted by turning the rotary knob ❶ .

The following appears in the display ❶ :

"d-01" and  for "beef"

"d-02" and  for "pork"



"d-03" and  for "poultry"

"d-04" and  for "fish"







"d-05" and  for "pizza"

"d-06" and  for "fruit/vegetables"

"d-07" and  for "potatoes"

4. When the required food appears in the display ❶, press the Start/quick start button ❶ .
5. Turn the rotary knob ❶  to set the weight.

The following weights can be set:

"d-01"/		/"beef"	100 - 1800g
"d-02"/		/"pork"	100 - 1800g
"d-03"/		/"poultry"	100 - 1800g
"d-04"/		/"fish"	100 - 1800g
"d-05"/		/"pizza"	100 - 900g
"d-06"/		/"fruit/vegetables"	100 - 900g
"d-07"/		/"potatoes"	100 - 900g

- When the required weight appears in the display **1**, press the Start/quick start button **14** . The appliance will then automatically calculate the required defrosting time.

### **Note**





To ensure optimum defrosting, it is necessary to turn the food during the defrosting process. The appliance will remind you to turn the food over by sounding a signal tone and showing "turn" in the display **1**. Open the appliance door, turn the food and then re-close the door. Press the Start/quick start button **14**  to continue the defrosting process.

If you do not want to turn the food, just wait for the signal tones to stop. The appliance will automatically continue the defrosting process. We recommend that you do turn the food. This will ensure even defrosting.

## Defrosting by time

### **Note**

Always place the food to be defrosted on dishes suitable for use in a microwave oven. Never place it directly on the turntable **3**!

- When in standby mode, turn the rotary knob **14**  anticlockwise until **1** "A-12" and  appear in the display.
- Press the Start/quick start button **14** .
- Now set the required time using the rotary knob **14**. 
- Press the Start/quick start button **14**  to start the defrosting process. The countdown begins.

### **Note**

To ensure optimum defrosting, it is necessary to turn the food during the defrosting process. The appliance will remind you to turn the food over by sounding a signal tone and showing "turn" in the display **1**. Open the appliance door, turn the food and then re-close the door. Press the Start/quick start button **14**  to continue the defrosting process.

If you do not want to turn the food, just wait for the signal tones to stop. The appliance will automatically continue the defrosting process. We recommend that you do turn the food. This will ensure an even defrosting.

## Recipes

---

### Meat patty

- Use around 125 g of minced beef to form each patty (diameter approx. 75 mm, height approx. 35mm).
- Distribute the patties evenly around the turntable ③.

### Preparation

You will achieve the best results if you alternate between the convection and microwave functions. Always wait until the set cooking process has completed before setting the next process.

1. Convection 200°C, 4:00 min.
2. Microwave 900 W power, 5:30 min.
3. Convection 200°C, 2:00 min.  
(depending on personal taste, a time of up to 4:00 min can also be used).

### Baking frozen ready-made bread rolls

- Select the convection function to bake bread rolls.
- Place 3-4 bread rolls on the turntable ③.

Pre-heating of the microwave is not required.

Select the following settings for the baking process:

- Convection 170°C, duration: 12 minutes

If you wish to bake additional rolls directly afterwards, shorten the baking time for these by about 1-2 minutes, as the appliance is now already pre-heated.

### Potato gratin

#### Ingredients

- 750 g waxy potatoes, peeled
- 300 g cream
- 100 g grated cheese with a fat content of 25% to 30 % fat in dry matter.
- Spices to taste (e.g., salt/pepper)

Use a microwave-proof, round dish with a lid, height 5-6 cm and a diameter of about 22 cm.

### Preparation

- Cut the potatoes into slices around 3 - 4 mm thick.
- Place around half of the potato slices in the baking dish in "roofing tile" formation.
- Sprinkle the potatoes with around half of the cheese.
- Add half of the spices in addition to approx. 150 g of cream.
- Now place the rest of the potato slices in "roofing tile" formation over the first layer.
- Sprinkle the rest of the cheese over the potatoes and pour the rest of the cream over this.
- Sprinkle the remaining spices over the gratin.
- Cover the dish with the cover and place it in the centre of the turntable ③.

### Preparation

You will achieve the best results if you alternate between the convection and microwave functions. Always wait until the set cooking process has completed before setting the next process.

1. Microwave 900 W power, 10:00 min.
2. Convection 200°C, 13:00 min.
3. Microwave 900 W power, 10:00 min.

Pre-heating is not required.

## Muffins

### Ingredients

This recipe yields 10 to 20 muffins.

- Baking margarine (80% fat content) or salted butter
- 170 g granulated sugar (up to 0.3 mm grain size)
- 3 eggs (55-60 g with shell/Size M)
- 225 g wheat flour
- 7 g baking powder
- 0,25 g salt

### Preparation

- Mix all ingredients well.
- Fill the muffin pastry into commercial paper baking cases (diameter 45 mm, height 28 mm)
- Preheat the oven with the convection function to 170°C.

### Note

*Should, due to the number of muffins, multiple baking operations be necessary, preheating is required only once.*

- Distribute the muffins evenly on the turntable .
- Select the following settings for the baking process:  
Convection 170°C, Duration: 12 Minutes

## Cleaning and Care

---

### Risk of injury!

*Before cleaning, switch the microwave oven off and remove the plug from the mains power socket.*

*Otherwise, there is the great risk of receiving an electric shock!*



UNDER NO CIRCUMSTANCES should you immerse the appliance in water or other liquids. This could result in you receiving a fatal electric shock and the appliance could be damaged.

- Always keep the interior of the microwave oven clean.
- If splashes of food or spilt liquids stick to the walls of the microwave, wipe them off with a damp cloth.
- Use a mild detergent if the microwave is more heavily soiled.
- Avoid using cleaning sprays and other aggressive cleaning agents, as they can cause stains, stripes or a blurring of the door surface. Clean the external walls with a damp cloth.
- To avoid damage to the functional components in the interior of the microwave, do not let liquids to seep in through the ventilation slits .
- Regularly remove splashes or contaminants. Clean the door, both sides of the viewing window, door seals and adjacent components with a damp cloth. Do not use abrasive cleaning agents.
- Should steam collect on or around the outside of the appliance door, wipe it off with a soft towel. This can happen if the microwave is operated in extremely humid conditions.

- Clean the turntable ❸ regularly. Clean the plate in warm soapy water.
- Clean the grill stand ❶ in warm dishwater and dry it well.
- Regularly eliminate odours. Place a deep microwave bowl with a cup of water and the juice and peel of a lemon into the microwave oven. Heat it up for 5 minutes. Wipe off thoroughly and rub dry with a cloth.
- Should replacement of the bulb in the microwave be necessary, arrange for it to be exchanged by a dealer or consult our Service Department.

## Troubleshooting

---

### The display ❶ indicates nothing.

- The plug is not inserted into a power socket. Check the plug.
- The mains power socket is defective. Try another mains power socket.
- The display ❶ is defective. Contact our Customer Services Department.

### The appliance does not respond to pressing the buttons.

- The Child safety facility is activated. Deactivate the Child safety facility (see chapter "Operation").

### The appliance does not start the cooking/warming process.

- The door is not properly closed. Close the door correctly.

### The turntable ❸ generates loud noise when revolving.

- The turntable ❸ is not correctly positioned on the axle. Insert the turntable ❸ correctly into the cooking area.
- The small rollers ❹ and/or the floor of the cooking area are unclean. Clean the rollers ❹ and the floor of the cooking area.

### The display ❶ indicates "E01" and signal tones sound.

- The microwave is overheated. Terminate the current programme immediately. Remove the plug from the mains power socket, open the microwave door and allow the appliance to cool down.

### The display ❶ indicates "E02" and signal tones sound.

- There is an error on the sensor. Interrupt the programme and let the appliance cool down. Then restart the microwave. If the error occurs again, contact Customer Support.
- There is an error during the heating up of the appliance. Interrupt the programme and let the appliance cool down. Then restart the microwave. If the error occurs again, contact Customer Support.

### The display ❶ indicates "E03" and signal tones sound.

- Due to a short circuit or open circuit voltage, the microwave has switched into fault protection. Stop the programme and remove the power plug. If possible, eliminate the problem, e.g. metals in the cooking area, which can lead to the above problem when using the microwave function. Otherwise, please contact our Customer Support.

## Disposal

---



**Do not dispose of this appliance in your normal domestic waste. This product is subject to the provisions of European Directive 2012/19/EU.**

Dispose of the appliance through an approved disposal centre or at your community waste facility. Observe the currently applicable regulations.

In case of doubt, please contact your waste disposal centre.



Dispose of all packaging materials in an environmentally friendly manner.

## Warranty and Service

---

You receive a 3-year warranty for this appliance as of the purchase date. This appliance has been manufactured with care and meticulously examined before delivery.

Please retain your receipt as proof of purchase. In the case of a warranty claim, please make contact by telephone with our service department. Only in this way can a post-free despatch for your goods be assured.

The warranty covers only claims for material and manufacturing defects, not for transport damages, worn parts or for damage to fragile components, e.g. buttons or batteries. This product is for private use only and is not intended for commercial applications.

In the event of misuse and improper handling, use of force and interference not carried out by our authorized service branch, the warranty will become void.. Your statutory rights are not restricted in any way by this warranty.

The warranty period is not extended by repairs effected under warranty. This applies also to replaced and repaired parts. Damages or defects discovered after purchase are to be reported directly after unpacking, at the latest two days after the purchase date. Repairs carried out after lapse of the warranty period are subject to charge.

**IT Assistenza Italia**

Tel.: 02 36003201

E-Mail: [kompernass@lidl.it](mailto:kompernass@lidl.it)

IAN 96324

**MT Assistenza Malta**

Tel.: 80062230

E-Mail: [kompernass@lidl.com.mt](mailto:kompernass@lidl.com.mt)

IAN 96324

**Raggiungibilità della hotline:**

dal lunedì al venerdì, dalle 8.00 alle 20.00 (CET)

## Importer

---

KOMPERNASS HANDELS GMBH

BURGSTRASSE 21

44867 BOCHUM

GERMANY

[www.kompernass.com](http://www.kompernass.com)

# INHALTSVERZEICHNIS

**SEITE**

<b>Einleitung</b>	<b>55</b>
<b>Bestimmungsgemäßer Gebrauch</b>	<b>55</b>
<b>Lieferumfang</b>	<b>55</b>
<b>Gerätebeschreibung</b>	<b>55</b>
<b>Technische Daten</b>	<b>55</b>
<b>Wichtige Sicherheitshinweise</b>	<b>56</b>
<b>Bevor Sie beginnen</b>	<b>62</b>
Grundprinzipien beim Kochen in der Mikrowelle .....	62
Geeignetes Kochgeschirr verwenden .....	62
<b>Erste Inbetriebnahme</b>	<b>63</b>
Gerät aufstellen .....	63
Gerät vorbereiten .....	63
Drehteller 3 einsetzen .....	64
<b>Bedienen</b>	<b>64</b>
Uhr einstellen .....	64
Standby-Modus .....	64
Küchentimer einstellen .....	64
Kindersicherung .....	65
Abfragefunktionen .....	65
Gar- oder Auftauvorgänge unterbrechen/abbrechen .....	65
<b>Kochen und Garen</b>	<b>65</b>
Mikrowellenbetrieb .....	65
Grill-Funktion .....	66
Kombinations-Garvorgang „Grill“ .....	67
Heißluftbetrieb .....	68
Heißluftbetrieb mit Vorheizen .....	69
Kombinations-Garvorgang „Heißluft“ .....	69
<b>Automatik-Menü</b>	<b>70</b>
Automatik-Menü starten .....	70
Pizza backen .....	72
<b>Auftauen</b>	<b>73</b>
Auftauen nach Gewicht .....	73
Auftauen nach Zeit .....	74



---

<b>Rezepte</b>	<b>75</b>
Frikadellen .....	75
Aufbacken von Tiefkühlfertigbrötchen .....	75
Kartoffelgratin.....	75
Muffins .....	76
<b>Reinigung und Pflege</b>	<b>76</b>
<b>Fehlerbehebung</b>	<b>77</b>
<b>Entsorgen</b>	<b>78</b>
<b>Garantie und Service</b>	<b>78</b>
<b>Importeur</b>	<b>78</b>

---

# Edelstahl-Mikrowelle

## Einleitung

Herzlichen Glückwunsch zum Kauf Ihres neuen Gerätes.

Sie haben sich damit für ein hochwertiges Produkt entschieden. Die Bedienungsanleitung ist Bestandteil dieses Produkts. Sie enthält wichtige Hinweise für Sicherheit, Gebrauch und Entsorgung. Machen Sie sich vor der Benutzung des Produkts mit allen Bedien- und Sicherheitshinweisen vertraut. Benutzen Sie das Produkt nur wie beschrieben und für die angegebenen Einsatzbereiche. Händigen Sie alle Unterlagen bei Weitergabe des Produkts an Dritte mit aus.

## Bestimmungsgemäßer Gebrauch

Dieses Gerät ist zum Erhitzen und Zubereiten von Lebensmitteln gemäß den beschriebenen Vorgehensweisen vorgesehen.

Jede Veränderung des Gerätes gilt als nicht bestimmungsgemäß und birgt erhebliche Unfallgefahren. Für aus bestimmungswidriger Verwendung entstandene Schäden übernimmt der Hersteller keine Haftung.

Dieses Gerät ist ausschließlich für die Benutzung in privaten Haushalten bestimmt!

Benutzen Sie es nicht gewerblich, in Industrie- oder Laborbereichen!

## Lieferumfang

Edelstahl-Mikrowelle  
Drehteller  
Grillständer  
Bedienungsanleitung  
Kurzinformation (2 Stück)

## Gerätebeschreibung

Abbildung A:

- 1 Display
- 2 Taste Türöffner
- 3 Drehteller
- 4 Rollen
- 5 Lüftungsschlitze

Abbildung B:

- 6 Taste Mikrowelle 
- 7 Taste Grill 
- 8 Taste Kombination Mikrowelle - Grill 
- 9 Taste Kombination Mikrowelle - Heißluft 
- 10 Taste Heißluft 
- 11 Taste Uhr 
- 12 Taste TIMER (Küchentimer)
- 13 Taste Stop/Kindersicherung 
- 14 Drehregler / Taste Start/Schnellstart 

Abbildung C:

- 15 Grillständer

## Technische Daten

Nennspannung: 230 - 240 V ~,  
50 Hz

Maximale Leistungsaufnahme

Mikrowelle: 1400 W

Grill: 1500 W

Heißluft: 1950 W

Maximale Leistungsabgabe

Mikrowelle: 900 W +/- 10%

Mikrowellen-Frequenz: 2450 MHz

# Wichtige Sicherheitshinweise

---

Lesen Sie die Sicherheitshinweise und die Bedienungsanleitung vor der ersten Verwendung aufmerksam durch und heben Sie diese für den späteren Gebrauch auf.

## **Achtung!**

Warnungen vor Beschädigungen am Gerät.

## **Gefahr!** / **Verletzungsgefahr!**

Warnung vor Verletzungen und elektrischem Schlag!

## **Brandgefahr!**

Warnung vor Brandgefahr.

## **Hinweis**

Hinweise und Tipps zur Handhabung der Mikrowelle.

## Vorsichtsmaßnahmen zur Vermeidung eines möglichen übermäßigen Kontaktes mit Mikrowellenenergie

- Versuchen Sie nicht, das Gerät bei geöffneter Tür zu betreiben, da der Betrieb bei geöffneter Tür zum Kontakt mit einer schädlichen Dosis Mikrowellenstrahlung führen kann. Wichtig ist hierbei auch, nicht die Sicherheitsverriegelungen aufzubrechen oder zu manipulieren.
- Klemmen Sie nichts zwischen Gerätefront und Tür und sorgen Sie dafür, dass sich keine Verschmutzungen oder Reinigungsmittelrückstände auf den Dichtflächen ansammeln.

## **Verletzungsgefahr!**

- Wenn die Tür oder die Türdichtungen beschädigt sind, betreiben Sie die Mikrowelle auf keinen Fall weiter. Lassen Sie sie sofort von qualifiziertem Fachpersonal reparieren.
- Versuchen Sie nie das Gerät selber zu reparieren. Durch das Abnehmen des Gehäuses kann Mikrowellenenergie freigesetzt werden. Lassen Sie Reparaturen nur von qualifiziertem Fachpersonal durchführen.
- Dieses Gerät kann von Kindern ab 8 Jahren und darüber und von Personen mit reduzierten physischen, sensorischen oder mentalen Fähigkeiten oder Mangel an Erfahrung und/oder Wissen benutzt werden, wenn sie beaufsichtigt oder bezüglich des sicheren Gebrauchs des Gerätes unterwiesen wurden und die daraus resultierenden Gefahren verstanden haben.
- Kinder dürfen nicht mit dem Gerät spielen.
- Reinigung und Benutzer-Wartung dürfen nicht durch Kinder durchgeführt werden, es sei denn, sie sind 8 Jahre und älter und werden beaufsichtigt.

- Kinder jünger als 8 Jahre sind vom Gerät und der Anschlussleitung fernzuhalten.
- Verwenden Sie dieses Gerät nur zum bestimmungsgemäßen Gebrauch gemäß Beschreibung in diesem Handbuch. Verwenden Sie in diesem Gerät keine ätzenden Chemikalien oder Dämpfe. Diese Mikrowelle ist speziell für Erhitzen, Kochen, Grillen oder Trocknen von Nahrungsmitteln konstruiert. Sie ist nicht für eine Nutzung im Industrie- oder Laborbereich konzipiert.
- Betreiben Sie die Mikrowelle nicht, wenn Netzkabel/Netzstecker beschädigt sind. Lassen Sie Netzkabel/Netzstecker von qualifiziertem Fachpersonal austauschen, um Gefährdungen zu vermeiden.
- Halten Sie Kinder von der Mikrowellentür fern, während diese in Betrieb ist. Verbrennungsgefahr!
- Entfernen Sie unter keinen Umständen das Mikrowellengehäuse.
- Lassen Sie die Lampe im Inneren der Mikrowelle nur von qualifiziertem Fachpersonal austauschen.
- Berühren Sie nie die Mikrowellentür, das Mikrowellengehäuse, die Lüftungsöffnungen, Zubehörteile oder das Essgeschirr direkt nach dem Grill-, Kombi- oder Automatikmenü-Vorgang. Die Teile werden sehr heiß. Lassen Sie vor dem Reinigen die Teile abkühlen.
- Achten Sie darauf, dass der Netzstecker immer gut zu erreichen ist, damit Sie diesen im Notfall schnell vom Stromnetz trennen können.
- Personen, die einen Herzschrittmacher tragen, sollten sich vor Inbetriebnahme der Mikrowelle bei ihrem Hausarzt über mögliche Risiken informieren.
- Lassen Sie das Netzkabel nie über den Tisch oder die Arbeitsplatte hängen. Kinder könnten daran ziehen.
- Öffnen Sie Dosen, Popcornütten etc. nach dem Erhitzen immer so, dass die Öffnung von Ihrem Körper weg zeigt. Austretender Dampf kann zu Verbrühungen führen.
- Stellen Sie sich nie direkt vor die Mikrowelle, wenn Sie die Tür öffnen. Austretender Dampf kann zu Verbrühungen führen.
- Frittieren Sie nicht in der Mikrowelle. Heißes Öl kann Geräteteile und Utensilien beschädigen und sogar Hautverbrennungen hervorrufen.
- Schütteln oder rühren Sie aufgewärmte Babygläschen oder Babyfläschchen auf jeden Fall um! Der Inhalt kann sich ungleichmäßig erhitzt haben und das Baby kann sich am Inhalt verbrennen. Kontrollieren Sie auf jeden Fall die Temperatur, bevor Sie Ihr Baby füttern!
- Bauen Sie die Mikrowelle nicht um.
- Mikrowellenstrahlen sind gefährlich! Lassen Sie Wartungs- oder Reparaturarbeiten, bei denen Abdeckungen zu entfernen sind, die vor einem Kontakt mit Mikrowellenstrahlen schützen, nur von geschultem Fachpersonal durchführen.

- Überprüfen Sie vor dem Verzehr die Temperatur, um für Babys u. U. lebensgefährliche Verbrennungen zu vermeiden. Kochutensilien können durch die von den erhitzten Speisen abgegebene Hitze heiß werden, so dass sie sich eventuell nur mit Topflappen anfassen lassen. Die Kochutensilien müssen daraufhin geprüft werden, ob sie mikrowelleneeignet sind.

 **Achtung! Heiße Oberfläche!**

### **Brandgefahr!**

- Lassen Sie die Mikrowelle nie unbeaufsichtigt, wenn Sie Lebensmittel in Plastik- oder Papierverpackungen erhitzen.
- Stellen Sie keine brennbaren Materialien in der Nähe der Mikrowelle oder der Lüftungsöffnungen auf.
- Entfernen Sie alle metallischen Verschlüsse der Verpackungen der Lebensmittel, die Sie erhitzen wollen. Brandgefahr!
- Benutzen Sie zur Herstellung von Popcorn nur mikrowelleneeignete Popcorn-Tüten.
- Benutzen Sie die Mikrowelle nicht, um mit Körnern, Kirschkernen oder Gel gefüllte Kissen zu erhitzen. Brandgefahr!
- Benutzen Sie die Mikrowelle nicht zur Lagerung von Lebensmitteln oder anderen Dingen.
- Überschreiten Sie nie die vom Hersteller angegebenen Garzeiten.
- Stellen Sie keine Gegenstände auf die Mikrowelle, während diese in Betrieb ist. Die Lüftungsöffnungen werden verdeckt!
- Stellen Sie die Mikrowelle nicht in der Nähe von anderen Hitze absondernden Geräten, wie zum Beispiel einem Backofen, auf.
- Reinigen Sie die Mikrowelle nach dem Erhitzen von fetthaltigen Speisen, insbesondere wenn diese nicht abgedeckt waren, gründlich. Lassen Sie das Gerät vollständig abkühlen, bevor Sie es reinigen. Auf den Heizelementen des Grills dürfen sich keine Rückstände, wie zum Beispiel Fett befinden. Dieses könnte überhitzen und sich entzünden.
- Tauen Sie kein gefrorenes Fett oder Öl in der Mikrowelle auf. Das Fett oder Öl kann sich entzünden.
- Benutzen Sie keine externe Zeitschaltuhr oder ein separates Fernwirksystem, um das Gerät zu betreiben.

- Diese Mikrowelle ist für die Erwärmung von Speisen und Getränken bestimmt. Trocknen von Speisen oder Kleidung und Erwärmung von Heizkissen, Hausschuhen, Schwämmen, feuchten Putzlappen und Ähnlichem kann zu Verletzungen, Entzündungen oder Feuer führen.

### **⚠ Achtung! Geräteschäden!**

- Betreiben Sie die Mikrowelle nicht im Leerzustand. Ausgenommen ist die erste Inbetriebnahme (siehe Kapitel „Erste Inbetriebnahme“).
- Stecken Sie keine Gegenstände in die Lüftungsöffnungen oder die Sicherheits-Türverriegelungen.
- Benutzen Sie keine metallischen Utensilien, die Mikrowellen reflektieren und zu Funkenbildung führen. Stellen Sie keine Blechdosen in die Mikrowelle.
- Stellen Sie keine Plastikbehälter sofort nach einem Grill-, Kombi- oder Automatikmenü-Vorgang in die Mikrowelle. Das Plastik kann schmelzen.
- Die Mikrowelle darf nicht an Orten mit hoher Luftfeuchtigkeit, oder wo sich Feuchtigkeit sammelt, aufgestellt werden.
- Flüssigkeiten und sonstige Nahrungsmittel dürfen nicht in luftdicht verschlossenen Behältern erhitzt werden, da diese explodieren und das Gerät beschädigen können.
- Lehnen Sie sich nicht auf die Mikrowellentür.
- Mangelhafte Sauberkeit des Kochgerätes kann zu einer Zerstörung der Oberfläche führen, die ihrerseits die Gebrauchsdauer beeinflusst und möglicherweise zu gefährlichen Situationen führt.

### **⚠ Gefahr!**

- Tauchen Sie nie das Netzkabel oder den Netzstecker in Wasser oder andere Flüssigkeiten.
- Halten Sie das Netzkabel von Hitzequellen fern. Führen Sie es nicht vor der Mikrowellentür her. Die Hitze kann das Kabel beschädigen.
- Schütten Sie niemals Flüssigkeiten in die Lüftungsöffnungen oder die Sicherheits-Türverriegelungen. Sollte doch Flüssigkeit hineingelangen, stellen Sie die Mikrowelle sofort aus und ziehen Sie den Netzstecker aus der Netzsteckdose. Lassen Sie die Mikrowelle von qualifiziertem Fachpersonal überprüfen.

## Sicherheitstipps

- *Um das Brandrisiko in der Mikrowelle zu minimieren: Behalten Sie, wenn Sie Speisen in Kunststoff- oder Papierbehältern erhitzen, die Mikrowelle immer im Auge, da sich die Materialien eventuell entzünden können.*
- *Beim Erhitzen von Getränken in der Mikrowelle kann es zu einem zeitlich verzögerten Sprudeln kommen, wenn das Getränk kocht. Seien Sie deshalb vorsichtig beim Hantieren mit dem Gefäß. Um plötzliches Sieden zu vermeiden:*
  - *Stellen Sie, wenn möglich, einen Glasstab in die Flüssigkeit, solange es erhitzt wird.*
  - *Lassen Sie die Flüssigkeit nach dem Erhitzen 20 Sekunden in der Mikrowelle stehen, um unerwartetes Aufbrodeln zu vermeiden.*
- *Durchstechen Sie die Haut von Kartoffeln, Würstchen oder ähnlichem. Sie können sonst explodieren.*
- *Seien Sie vorsichtig beim Erhitzen von Flüssigkeiten. Benutzen Sie nur offene Gefäße, damit entstehende Luftblasen entweichen können.*
- *Wenn das Gerät Rauch abgibt, ist das Gerät abzuschalten oder der Stecker zu ziehen und die Tür geschlossen zu halten, um eventuell auftretende Flammen zu ersticken.*
- *Eier in der Schale und hart gekochte Eier dürfen nicht in der Mikrowelle erhitzt werden, da sie selbst noch nach der Beendigung des Erhitzens in der Mikrowelle explodieren können.*

*Nahrungsmittel mit dicker Schale, wie etwa Kartoffeln, ganze Kürbisse, Äpfel und Kastanien vor dem Kochen einstechen.*
- *Bewegen Sie die Mikrowelle nicht, während sie in Betrieb ist.*

## **Erdungshinweise/ordnungsgemäße Installation**

Das vorliegende Gerät muss geerdet sein. Dieses Gerät ist nur an eine vorschriftsmäßig geerdete Steckdose anzuschließen. Es wird empfohlen, einen eigenen Stromkreis zu verwenden, der nur die Mikrowelle versorgt.

**⚠ Gefahr:** *Unsachgemäßer Umgang mit dem Erdungsstecker kann das Risiko eines elektrischen Schlages nach sich ziehen.*

**ⓘ Hinweis:** *Sollten Sie Fragen zum Erden oder den Anweisungen in Sachen Elektrik haben, fragen Sie eine Elektro- oder Wartungsfachkraft.*

Weder der Hersteller noch der Händler können die Haftung für eine Beschädigung der Mikrowelle oder für Personenschäden übernehmen, die auf eine Nichtbeachtung der Verfahrenshinweise für den Elektroanschluss zurückgehen.

## **Funktstörungen bei anderen Geräten**

Der Betrieb der Mikrowelle kann Störungen bei Ihrem Radio, Fernseher oder ähnlichen Geräten hervorrufen.

Falls solche Interferenzen auftreten sollten, lassen sie sich mit Hilfe der folgenden Maßnahmen vermindern oder ausschalten:

- Tür und Dichtfläche der Mikrowelle säubern.
- Empfangsantenne des Radios oder Fernsehers neu ausrichten.
- Mikrowelle an einen anderen Ort stellen als den, an dem der Empfänger steht.
- Entfernen Sie die Mikrowelle vom Empfänger.
- Stecken Sie die Mikrowelle in eine andere Steckdose ein. Mikrowelle und Empfänger sollten einen unterschiedlichen Zweig des Stromkreises in Anspruch nehmen.



# Bevor Sie beginnen

## Grundprinzipien beim Kochen in der Mikrowelle

- Ordnen Sie die Speisen wohlbedacht an.
- Die dicksten Stellen kommen in Randnähe.
- Achten Sie auf die Garzeit. Wählen Sie die kürzeste angegebene Garzeit und verlängern Sie diese bei Bedarf. Massiv zu lange gekochte Speisen können zu rauchen beginnen oder sich entzünden.
- Versehen Sie die Speisen während des Garens mit einem für die Mikrowelle geeigneten Deckel. Der Deckel verhindert ein Spritzen und trägt außerdem dazu bei, dass Speisen gleichmäßig gar werden.
- Wenden Sie die Speisen während der Zubereitung in der Mikrowelle einmal, damit Gerichte wie Hähnchen oder Hamburger schneller „durch“ sind.
- Große Lebensmittelstücke wie etwa Braten müssen mindestens einmal gewendet werden.
- Sortieren Sie Lebensmitteleile wie etwa Hackbällchen nach der halben Garzeit komplett um. Wenden Sie sie, und platzieren Sie die Bällchen von der Mitte des Geschirrs an den Rand.

## Geeignetes Kochgeschirr verwenden

- Das ideale Material für einen Mikrowellenherd ist mikrowellendurchlässig, lässt also die Energie durch den Behälter hindurch, um die Speise zu erwärmen. Mikrowellen sind nicht in der Lage, Metall zu durchdringen. Aus diesem Grund dürfen keine Metallgefäße und kein Metallgeschirr verwendet werden.

- Verwenden Sie beim Erhitzen in der Mikrowelle keine Erzeugnisse aus Recyclingpapier. Diese können winzige Metallfragmente enthalten, die Funken und/oder Brände erzeugen können.
- Es empfiehlt sich eher rundes/ovales Geschirr statt eckiges/längliches, da Speisen im Eckbereich leicht verkochen.  
Die nachstehende Liste versteht sich als allgemeine Hilfe für die Wahl des korrekten Geschirrs.

Kochgeschirr	Mikrowelle	Grill	Heißluft	Kombination
Hitzebeständiges Glas	Ja	Ja	Ja	Ja
Nicht hitzebeständiges Glas	Nein	Nein	Nein	Nein
Hitzebeständige Keramik	Ja	Ja	Ja	Ja
Mikrowellengeeignetes Plastikgeschirr	Ja	Nein	Nein	Nein
Küchenpapier	Ja	Nein	Nein	Nein
Metalltablett/-platte	Nein	Ja	Ja	Nein
Grillständler	Nein	Ja	Ja	Nein
Alufolie & Folienbehälter	Nein	Ja	Ja	Nein

## **Brandgefahr!**

Benutzen Sie niemals den Grillständer oder andere metallische Gegenstände, wenn Sie die Mikrowelle im Mikrowellenbetrieb oder im Kombinations-Garvorgang verwenden. Metall reflektiert die Mikrowellenstrahlung und führt so zu Funkenbildung. Das kann zu einem Brand führen und das Gerät irreparabel beschädigen!

## Erste Inbetriebnahme

---

### Gerät aufstellen

#### **Brandgefahr!**

Diese Mikrowelle ist nicht für den Einbau in einen Küchenschrank geeignet. In geschlossenen Schränken ist die Belüftung des Gerätes nicht ausreichend gewährleistet. Das Gerät kann beschädigt werden und es besteht die Gefahr eines Brandes!

- Wählen Sie eine ebene Fläche, die genug Abstand für die Be- und Entlüftung des Gerätes lässt:  
Halten Sie zwischen Gerät und den angrenzenden Wänden einen Mindestabstand von 10 cm unbedingt ein. Stellen Sie sicher, dass sich die Tür der Mikrowelle einwandfrei öffnen lässt.  
Halten Sie über der Mikrowelle einen Abstand von mindestens 20 cm.
- Sorgen Sie dafür, dass der Netzstecker problemlos zugänglich ist, damit er im Fall von Gefahren mühelos erreicht und gezogen werden kann.
- Entfernen Sie nicht die Füße unter dem Mikrowellengerät.
- Blockieren Sie nicht die Lüftungsschlitze **5**. Andernfalls kann es zu Beschädigungen des Geräts kommen.

- Stellen Sie das Gerät möglichst weit entfernt von Radio- und Fernsehgeräten auf. Der Betrieb der Mikrowelle kann Störungen des Radio- oder Fernsehempfangs hervorrufen.

#### **Achtung:**

Stellen Sie die Mikrowelle nicht über einem Küchenherd oder einem sonstigen Hitze erzeugenden Gerät auf. Eine Aufstellung an einem solchen Ort könnte zur Beschädigung des Gerätes und damit auch zum Erlöschen der Garantie führen.

### Gerät vorbereiten

- Entfernen Sie das Verpackungsmaterial und die auf dem Panel und der Taste Türöffner **2** angebrachte Schutzfolie.









Entfernen Sie nicht die hellgraue Glimmer-Abdeckplatte, die zum Schutz der Magnetfeldröhre im Garraum angebracht ist.

- Stecken Sie den Netzstecker in eine Netzsteckdose. Benutzen Sie eine 230 - 240 V ~, 50 Hz, Netzsteckdose mit einer 16 A Sicherung. Es wird empfohlen, dass ein eigener Stromkreis die Mikrowelle versorgt. Wenn Sie sich nicht sicher sind, wie Sie die Mikrowelle anschließen sollen, ziehen Sie einen Fachmann zu Rate.

Vor dem Verwenden der Mikrowelle muss das Gerät zunächst leer aufgeheizt werden, damit fettigungsbedingte Rückstände verdampfen können.

Nachdem Sie den Stecker in die Steckdose gesteckt haben, öffnen Sie einmal die Tür der Mikrowelle durch Drücken der Taste Türöffner **2**.

Schalten Sie das Gerät ohne Lebensmittel und ohne Zubehör (Drehteller **3** und Grillständer **15**) in der Betriebsart Grillen ein:

- Drücken Sie die Taste Grill **7** . Im Display erscheint "Gr 1".
- Drehen Sie den Drehregler **14** , bis "Gr 3" und die Symbole  und  im Display erscheinen und bestätigen Sie die Auswahl durch Drücken auf die Taste Start/Schnellstart **14** .
- Stellen Sie mit dem Drehregler **14**  eine Garzeit von 10 Minuten ein.
- Drücken Sie die Taste Start/Schnellstart **14** , um den Grillvorgang zu starten.

### **Hinweis**

Bei der ersten Inbetriebnahme kann es durch fertigungsbedingte Rückstände zu leichter Rauch- und Geruchsentwicklung kommen. Dieses ist unschädlich. Sorgen Sie für eine ausreichende Belüftung. Öffnen Sie zum Beispiel ein Fenster.

- Nach 10 Minuten schaltet sich das Gerät automatisch aus. Warten Sie, bis es vollständig abgekühlt ist.
- Ziehen Sie den Netzstecker aus der Steckdose und reinigen Sie das Gerät anschließend innen mit einem feuchten Tuch und trocknen Sie es sorgfältig ab.

### **Drehteller **3** einsetzen**



- Setzen Sie den Drehteller **3** mittig auf die Achse im Garraum. Achten Sie darauf, dass er komplett auf die Achse rutscht und fest sitzt.

## **Bedienen**

### **Uhr einstellen**





Nachdem Sie den Stecker in die Steckdose gesteckt haben, öffnen Sie die Tür der Mikrowelle einmal. Das Display **1** zeigt "1:00" an. Schließen Sie die Tür wieder.

1. Drücken Sie die Taste Uhr **11** . Im Display **1** erscheint „Hr 12“.

2. Wählen Sie durch Drehen am Drehregler **14**  den gewünschten Modus (Hr 24 oder Hr 12) und bestätigen Sie Ihre Auswahl durch Drücken auf die Taste Start/Schnellstart **14** .

### **Hinweis**

Erst beim anschließendem Drehen des Drehreglers  **14**, erscheint die Anzeige der Uhrzeit und man kann die Stunde einstellen.

3. Stellen Sie durch Drehen am Drehregler **14**  die gewünschte Stunde ein und bestätigen Sie Ihre Auswahl durch Drücken auf die Taste Start/Schnellstart **14** .
  4. Stellen Sie durch Drehen am Drehregler **14**  die gewünschten Minuten ein und bestätigen Sie Ihre Auswahl durch Drücken auf die Taste Start/Schnellstart **14** .
- Die Uhrzeit ist nun eingestellt.



Um die aktuelle Tageszeit abzulesen, während die Mikrowelle in Betrieb ist, drücken Sie die Taste Uhr **11** ; die Uhrzeit wird dann einige Sekunden im Display **1** angezeigt.

### **Standby-Modus**

Die Mikrowelle schaltet automatisch in den Standby-Modus und die Uhrzeit wird angezeigt, wenn für längere Zeit keine Taste gedrückt wird. Wenige Sekunden nach der Umstellung in den Standby-Modus wird auch die Displaybeleuchtung gedimmt.

### **Küchentimer einstellen**

Die Mikrowelle verfügt über einen Küchentimer, den Sie unabhängig vom Mikrowellenbetrieb einsetzen können.

1. Drücken Sie die Taste TIMER **12**, wenn das Gerät im Standby-Betrieb ist. Im Display **1** erscheint „0:00“ und das Symbol .
2. Stellen Sie nun mit dem Drehregler **14**  die gewünschte Zeit ein. Sie können Zeiteinstellungen von 10 Sekunden bis 95 Minuten vornehmen.







3. Drücken Sie die Taste Start/Schnellstart **14**  . Ein Signalton ertönt. Die Zeit zählt rückwärts herunter. Nach ca. 3 Sekunden wird die normale Uhrzeit wieder angezeigt. Der Küchentimer läuft im Hintergrund weiter. Wenn Sie zwischendurch die Zeit des Küchentimers kontrollieren wollen, drücken Sie die Taste TIMER **12**. Es erscheint für kurze Zeit der Küchentimer.

Sobald die eingestellte Zeit abgelaufen ist, ertönen Signaltöne.

## Kindersicherung

Aktivieren Sie diese Einstellung, um eine unbeaufsichtigte Inbetriebnahme der Mikrowelle durch Kleinkinder und andere nicht mit der Bedienung vertraute Personen zu verhindern.

Das Symbol für die Kindersicherung  erscheint im Display **1** , und das Gerät kann solange, wie diese Funktion aktiviert ist, nicht in Betrieb genommen werden.

- Drücken Sie die Taste Stop/Kindersicherung **13**  +  und halten Sie sie solange gedrückt, bis ein Signalton ertönt und das Symbol für die Kindersicherung  im Display **1** erscheint. Die Tasten und der Regler der Mikrowelle haben nun keine Funktion mehr.
- Um die Kindersicherung zu deaktivieren, drücken Sie die Taste Stop/Kindersicherung **13**  +  und halten Sie sie solange gedrückt bis ein Signalton ertönt und das Symbol für die Kindersicherung  erlischt.

## Abfragefunktionen





### Uhrzeit während des Betriebs abfragen

Drücken Sie während des Garvorgangs die Taste Uhr **11**  . Im Display **1** erscheint für einige Sekunden die Uhrzeit.

### Leistungsstufe während des Betriebs abfragen

Drücken Sie während des Garvorgangs die Taste Mikrowelle **6**  . Im Display **1** erscheint für einige Sekunden die aktivierte Leistungsstufe.

## Gar- oder Auftauvorgänge unterbrechen/abbrechen

- Drücken Sie einmal die Taste Stop **13**  +  , um einen Gar- oder Auftauvorgang zu unterbrechen. Das Gerät unterbricht den Vorgang und stoppt die noch verbleibende Zeit. Drücken Sie die Taste Start/Schnellstart **14**  , um den Vorgang wieder fortzusetzen.
- Drücken Sie zweimal die Taste Stop **13**  +  , um einen Garvorgang abzubrechen. Das Gerät schaltet wieder in den Standby-Betrieb zurück.

## Kochen und Garen

### Hinweis

*Diese Mikrowelle ist mit einer Abkühlfunktion ausgestattet. D.h., dass nach einem Gar- oder Grillvorgang, der mindestens 2 Minuten dauert, der Lüfter des Gerätes noch für etwa. 3 Minuten nachläuft. Das ist keine Fehlfunktion des Gerätes! Das schnelle Abkühlen hilft, die Lebensdauer des Gerätes zu verlängern.*

### Mikrowellenbetrieb



#### Hinweis

*Auf der Mikrowellentür oder dem Gehäuse können sich während eines Garvorgangs Wassertropfen bilden. Das ist normal und kein Zeichen für eine Fehlfunktion der Mikrowelle. Wischen Sie die Feuchtigkeit nachdem sie abgekühlt ist mit einem trockenen Tuch ab.*

#### Brandgefahr!

*Benutzen Sie niemals den Grillständer **15** oder andere metallische Gegenstände, wenn Sie die Mikrowelle im Mikrowellenbetrieb verwenden. Metall reflektiert die Mikrowellenstrahlung und führt so zu Funkenbildung. Das kann zu einem Brand führen und das Gerät irreparabel beschädigen!*

## Leistung auswählen

1. Drücken Sie die Taste Mikrowelle **6** . Im Display **1** erscheint "900" (900 Watt Leistung).
2. Stellen Sie mit Hilfe des Drehreglers **14**  die gewünschte Leistung ein.
3. Drücken Sie die Taste Start/Schnellstart **14** , um die eingestellte Leistung zu bestätigen.

## Garzeit einstellen



Nachdem Sie die Leistung ausgewählt haben, stellen Sie die gewünschte Garzeit ein:

- Drehen Sie den Drehregler **14** , bis die gewünschte Garzeit eingestellt ist.



## Die Stufen für die Einstellungszeit des Drehreglers **14** sind wie folgt:

- von 0 Sek. bis 5 Min: in 10-Sek.-Schritten
- von 5 bis 10 Min: in 30-Sek.-Schritten
- von 10 bis 30 Min: in 1-Min.-Schritten
- von 30 bis 95 Min: in 5-Min.-Schritten



## Eingabevorgang abbrechen/beenden

Drücken Sie einmal die Taste Stop **15**  + , um einen Eingabevorgang abzubrechen und zu beenden. Das Gerät schaltet wieder in den Standby-Betrieb zurück.

## Garvorgang starten



Wenn Sie die Leistung und die Garzeit eingestellt haben, können Sie den Garvorgang starten: Drücken Sie zum Starten des Garvorgangs die Taste Start/Schnellstart **14** . Im Display **1** erscheint das Symbol für Mikrowellenbetrieb . Die eingestellte Zeit zählt rückwärts herunter. Wenn die eingestellte Zeit abgelaufen ist, erscheint abwechselnd „End“ und „Hot“ im Display **1**. Ein Signalton ertönt mehrmals hintereinander.

## Schnellstart 1

Drehen Sie im Standby-Modus den Drehregler **14**  nach rechts und stellen Sie die gewünschte Dauer des Garens ein. Starten Sie den Garvorgang mit 900 W Leistung durch Drücken der Taste Start/Schnellstart **14** .

## Schnellstart 2

Mit dieser Funktion können Sie unverzüglich für 30 Sekunden (oder länger, bis zu 95 Minuten) bei 900 W Leistung mit dem Garen beginnen.

- Drücken Sie einmal die Taste Start/Schnellstart **14** . Im Display **1** erscheint das Symbol für Mikrowellenbetrieb , sowie „00:30“. Die Mikrowelle startet den Garvorgang für 30 Sekunden. Die Zeit zählt rückwärts herunter.

Wenn Sie länger als 30 Sekunden garen wollen, drücken Sie so oft auf die Taste Start/Schnellstart **14** , bis die gewünschte Zeit erreicht ist.

Die Zeit-Stufen teilen sich wie folgt auf:

- von 30 Sek. bis 5 Min: in 30-Sek.-Schritten
- von 5 Min. bis 95 Min: in 1-Min.-Schritten

## Grill-Funktion

### **Hinweis**













Benutzen Sie zum Grillen immer den Grillständer **15**. So erzielen Sie ein optimales Grillergebnis. Stellen Sie den Grillständer **15** immer auf den Drehteller **3**.





### **Brandgefahr!**

Benutzen Sie bei Verwendung der Grill-Funktionen auf keinen Fall Abdeckungen oder nicht hitzebeständiges Geschirr, da diese schmelzen oder in Brand geraten können!

Es stehen Ihnen 3 Grill-Funktionen zur Verfügung:

- Grill-Funktion „Oberhitze“ (Gr 1):  
Die Hitze kommt bei dieser Funktion nur von oben. Nur der obere Grill ist aktiviert. Daher eignet sich diese Grill-Funktion für überbackene Sandwiches und Gratins.
- Grill-Funktion „Unterhitze“ (Gr 2):  
Die Hitze kommt bei dieser Funktion nur von unten. Nur der untere Grill ist aktiviert. Daher eignet sich diese Grill-Funktion für Gerichte oder Lebensmittel, die von unten gegart/gegrillt werden müssen.
- Grill-Funktion „Ober- und Unterhitze“ (Gr 3):  
Die Hitze kommt bei dieser Funktion von oben und von unten. Der obere und der untere Grill sind aktiviert. Daher eignet sich diese Grill-Funktion für dünne Scheiben Fleisch, Steaks, Frikadellen, Würstchen oder Hähnchenteile.

1. Drücken Sie die Taste Grill   einmal, um die Grill-Funktion zu aktivieren.  
Im Display  erscheint das Symbol für die Grill-Funktion „Oberhitze“  und „Gr 1“.
2. Stellen Sie mit dem Drehregler   die gewünschte Grill-Funktion ein:  
„Gr 1“ für Oberhitze,  
„Gr 2“ für Unterhitze,  
„Gr 3“ für Ober- und Unterhitze.  
Bestätigen Sie Ihre Auswahl durch Drücken der Taste Start/Schnellstart  .
3. Stellen Sie mit dem Drehregler   die gewünschte Garzeit ein. Die maximal einstellbare Garzeit beträgt 95 Minuten.
4. Drücken Sie zum Starten der Grill-Funktion die Taste Start/Schnellstart  .

Im Display  erscheint das Symbol für die ausgewählte Grill-Funktion  /  / . Die eingestellte Zeit zählt rückwärts herunter. Wenn die eingestellte Zeit abgelaufen ist, erscheint abwechselnd „End“ und „Hot“ im Display . Ein Signalton ertönt mehrmals hintereinander.

## Kombinations-Garvorgang „Grill“

Diese Funktion vereint die Grill-Funktion mit dem normalen Mikrowellenbetrieb. Während des Kombinationsvorgangs wird eine bestimmte Zeit für Garen und die übrige Zeit für Grillen automatisch und in einem Vorgang ausgeführt. Den Umschaltzeitpunkt des Gerätes können Sie durch ein leises Klicken wahrnehmen.

### **Brandgefahr!**

Benutzen Sie niemals den Grillständer  oder andere metallische Gegenstände, wenn Sie die Mikrowelle im Kombinations-Garvorgang verwenden. Metall reflektiert die Mikrowellenstrahlung und führt so zu Funkenbildung. Das kann zu einem Brand führen und das Gerät irreparabel beschädigen!









Benutzen Sie bei Verwendung der Kombinations-Garvorgängen „Grill“ auf keinen Fall Abdeckungen oder nicht hitzebeständiges Geschirr, da diese schmelzen oder in Brand geraten können!





Es stehen Ihnen 4 Kombinationen zur Verfügung:

- Kombination 1 (C 1):  
Bei der Kombination 1 beträgt die Mikrowellenleistung 30 % und die Grill-Leistung 70 % der Garzeit. Dies ist z. B. geeignet für Fisch oder Gratins. Es wird die Mikrowellenfunktion und die Grill-Funktion „Oberhitze“ benutzt.
- Kombination 2 (C 2):  
Bei der Kombination 2 beträgt die Mikrowellenleistung 55 % und die Grill-Leistung 45 % der Garzeit. Dies ist z. B. geeignet für Omelettes, Puddings oder Lasagne. Es wird die Mikrowellenfunktion und die Grill-Funktion „Oberhitze“ benutzt.
- Kombination 3 (C 3):  
Bei der Kombination 3 beträgt die Mikrowellenleistung 30 % und die Grill-Leistung 70 % der Garzeit. Dies eignet sich beispielsweise für Kartoffeln. Es wird die Mikrowellenfunktion und die Grill-Funktion „Ober- und Unterhitze“ benutzt.

- Kombination 4 (C 4):







Bei der Kombination 4 beträgt die Mikrowellenleistung 55 % und die Grill-Leistung 45 % der Garzeit. Dies eignet sich beispielsweise für Geflügelgerichte. Es wird die Mikrowellenfunktion und die Grill-Funktion „Ober- und Unterhitze“ benutzt.



1. Drücken Sie die Taste Kombination Mikrowelle-Grill  einmal, um die Kombination 1 (C 1) zu aktivieren. Im Display  erscheinen , , sowie „C 1“.
2. Stellen Sie mit dem Drehregler  die gewünschte Kombination ein:  
 „C 1“ für Kombination 1,  
 „C 2“ für Kombination 2,  
 „C 3“ für Kombination 3,  
 „C 4“ für Kombination 4.  
 Bestätigen Sie Ihre Auswahl durch Drücken der Taste Start/Schnellstart  .
3. Stellen Sie mit dem Drehregler  die gewünschte Garzeit ein. Die maximal einstellbare Garzeit beträgt 95 Minuten.
4. Drücken Sie zum Starten die Taste Start/Schnellstart  .

Im Display  erscheinen die Symbole der jeweils verwendeten Garvorgänge , , . Die eingestellte Zeit zählt rückwärts herunter. Wenn die eingestellte Zeit abgelaufen ist, erscheint abwechselnd „End“ und „Hot“ im Display . Ein Signalton ertönt mehrmals hintereinander.

## Heißluftbetrieb









Beim Garen mit Heißluft zirkuliert heiße Luft im Garraum. Heißluft ist besonders zum Zubereiten von Aufläufen oder knusprigen Lebensmitteln zu empfehlen. Sie können eine Temperatur von 110°C - 200°C einstellen und eine Dauer von max. 95 Minuten.

1. Drücken Sie die Taste Heißluft . Im Display erscheint „200C“ (= 200°C) und das Symbol für Heißluftbetrieb .
2. Stellen Sie mit dem Drehregler  die gewünschte Temperatur ein und bestätigen Sie die Auswahl durch Drücken auf die Taste Start/Schnellstart  .
3. Stellen Sie mit dem Drehregler  die gewünschte Garzeit ein.
4. Drücken Sie zum Starten des Garvorgangs die Taste Start/Schnellstart  .

Im Display  erscheint das Symbol für Heißluftbetrieb . Die eingestellte Zeit zählt rückwärts herunter. Wenn die eingestellte Zeit abgelaufen ist, erscheint abwechselnd „End“ und „Hot“ im Display . Ein Signalton ertönt mehrmals hintereinander.

## Heißluftbetrieb mit Vorheizen

Sie können Ihre Mikrowelle auch vorheizen, bevor Sie einen Garvorgang starten:

1. Wählen Sie die gewünschte Temperatur, indem Sie die Taste Heißluft **10**  einmal drücken und mit dem Drehregler **14**  die Temperatur einstellen. Bestätigen Sie diese Einstellung NICHT durch Drücken der Taste Start/Schnellstart **14** .
2. Drücken Sie, um das Vorheizen zu starten, die Taste Heißluft **10** . Im Display **1** erscheint „30:00“ und das Symbol für Heißluftbetrieb  blinkt. Die Zeit zählt herunter. Sobald die eingestellte Temperatur erreicht ist, erklingen Signaltöne und die Zeit stoppt.
3. Öffnen Sie die Tür und stellen Sie das zu garende Lebensmittel hinein.
4. Stellen Sie die Temperatur durch Drehen des Drehreglers **14**  ein und bestätigen Sie die Temperatur durch Drücken der Taste Start/Schnellstart **14** .
5. Stellen Sie mit dem Drehregler **14**  die gewünschte Garzeit ein. Die maximal einstellbare Garzeit beträgt 95 Minuten.
6. Drücken Sie zum Starten die Taste Start/Schnellstart **14** .







Im Display **1** erscheint das Symbol für Heißluftbetrieb  dauerhaft. Die eingestellte Zeit zählt rückwärts herunter. Wenn die eingestellte Zeit abgelaufen ist, erscheint abwechselnd „End“ und „Hot“ im Display **1**. Ein Signalton ertönt mehrmals hintereinander.



## Kombinations-Garvorgang „Heißluft“

Diese Funktion vereint die Heißluft-Funktion mit dem normalen Mikrowellenbetrieb. Dadurch wird zum Beispiel Fleisch saftig, zart und trotzdem knusprig.

### **Brandgefahr!**

*Benutzen Sie niemals den Grillständer **15** oder andere metallische Gegenstände, wenn Sie die Mikrowelle im Kombinations-Garvorgang verwenden. Metall reflektiert die Mikrowellenstrahlung und führt so zu Funkenbildung. Das kann zu einem Brand führen und das Gerät irreparabel beschädigen!*

1. Drücken Sie die Taste Kombination Mikrowelle-Heißluft **9** . Im Display **1** erscheinen die voreingestellte Temperatur „200C“ und die Symbole  und .
2. Wählen Sie die gewünschte Temperatur mit Hilfe des Drehreglers **14**  : 110°C, 140°C, 170°C oder 200°C. Bestätigen Sie Ihre Auswahl durch Drücken der Taste Start/Schnellstart **14** .
3. Stellen Sie mit dem Drehregler **14**  die gewünschte Garzeit ein. Die maximale Garzeit beträgt 95 Minuten. Bestätigen Sie die eingestellte Garzeit durch Drücken der Taste Start/Schnellstart **14** .

Der Kombinationsvorgang startet. Im Display **1** erscheinen die Symbole für den Kombinations-Garvorgang „Heißluft“ , . Die eingestellte Zeit zählt rückwärts herunter. Wenn die eingestellte Zeit abgelaufen ist, erscheint abwechselnd „End“ und „Hot“ im Display **1**. Ein Signalton ertönt mehrmals hintereinander.



# Automatik-Menü

Für Speisen, die im Automatik-Menümodus zubereitet werden sollen, ist es nicht notwendig, die Dauer des Garvorgangs und die Leistungsstufe einzugeben. Es reicht vielmehr aus, wenn Sie eingeben, welche Art Lebensmittel gegart/gekocht werden soll, sowie das Gewicht dieses Lebensmittels.

## **Brandgefahr!**





Benutzen Sie bei Programmen mit zugeschalteter Grillfunktion (A-01, A-02, A-03, A-04, A-05) auf keinen Fall Abdeckungen oder nicht hitzebeständiges Geschirr, da diese schmelzen oder in Brand geraten können!

## **Hinweis**



Die Mikrowelle berechnet die Zeit/Leistungsstufe für **frische** Lebensmittel. Tiefgekühlte Lebensmittel werden mit den von der Mikrowelle vorgegebenen Zeiten nicht gar (ausgenommen Automatik-Programm „Pizza“).













Tauen Sie ggf. tiefgekühlte Lebensmittel mit dem Auftau-Programm vorher auf (siehe Kapitel „Auftau“).

## Automatik-Menü starten



1. Drehen Sie den Drehregler   (im Stand-by-Betrieb) langsam nach links, um den Automatik-Menümodus aufzurufen. Im Display  erscheint eine Nummer (z. B. „A - 02“ für Automatikprogramm 2 (Schwein)) und das Symbol „Schwein“. Wählen Sie durch Drehen des Drehreglers   das passende Automatik-Menü zu Ihrer Speise aus.



## **Hinweis**

Wenn Sie durch eine Linksdrehung des Drehreglers   in den Automatik-Menümodus gelangt sind, können Sie durch anschließendes Drehen nach Rechts die Automatik-Menüs in der Reihenfolge A01, A02, A03... auswählen.

Display	Symbol	Lebensmittel	Gewicht
A-01		Rind	200 - 1400g
A-02		Schwein	200 - 1400g
A-03		Geflügel	400 - 1400g
A-04		Fisch	200 - 1200g
A-05		Pizza	*P1 150-450g P2 150-450g P3 150-450g
A-06		Obst/ Gemüse	100 - 1000g
A-07		Kartoffeln	100 - 800g
A-08		Aufwärmen	300 - 700g
A-09		Getränke	200 - 500ml
A-10		Vorspeise	300 / 500g
A-11		Auftauen nach Ge- wicht	-
A-12		Auftauen nach Zeit	-





\*Für weitere Informationen über die Pizza-Programme lesen Sie das Kapitel "Pizza backen".

- Bestätigen Sie Ihre Auswahl durch Drücken der Taste Start/Schnellstart **14** .
- Stellen Sie das Gewicht mit Hilfe des Drehreglers **14**  ein und bestätigen Sie dieses durch Drücken der Taste Start/Schnellstart **14** .

Der Garvorgang wird gestartet. Im Display erscheinen die Symbole der Gar- und Grill-Funktionen, die für das gewählte Automatik-Programm verwendet werden: Mikrowellenfunktion , Grill-Funktion Oberhitze , Grill-Funktion Unterhitze . Die errechnete Zeit läuft rückwärts herunter.

### **Hinweis**

Um ein gleichmäßiges Kochen oder Garen zu erreichen, sollten einige Speisen nach 2/3 der Garzeit gewendet werden. Die Mikrowelle stoppt nach dieser Zeit automatisch, 4 Signaltöne erklingen und „Turn“ erscheint im Display .

Display	Symbol	Lebensmittel	Wenden nach...
A-01		Rind	2/3 der Zeit
A-02		Schwein	2/3 der Zeit
A-03		Geflügel	2/3 der Zeit
A-04		Fisch	2/3 der Zeit



- Wenden Sie die Speisen. Gehen Sie vorsichtig mit den eventuell schon heißen Speisen um.
- Drücken Sie die Taste Start/Schnellstart **14** , um den Garvorgang wieder fortzusetzen.





### **Hinweis**







Wenn Sie die Speisen nicht wenden wollen, warten Sie nach den Signaltönen einfach ab. Das Gerät setzt den Garvorgang automatisch fort. Wir empfehlen das Wenden der Speisen. Damit erreichen Sie ein gleichmäßiges Garen.

### **Hinweis**

Wenn das Gericht nach dem Beenden des Automatik-Menüs nicht richtig durchgegart ist, garen Sie es wie folgt nach:

- Benutzen Sie zum Nachgaren den in der Tabelle angegebene Garvorgang. Starten Sie diesen für jeweils wenige Minuten und kontrollieren Sie das Garergebnis.
- Bei dem Nachgaren einer Pizza mit Hilfe des Automatikmenüse "P2" unterbrechen Sie den Garvorgang durch Drücken der Taste Stop/Kindersicherung  + , sobald die Pizza genug nachgegart ist.

Display	Symbol	Lebensmittel	Nachgaren mit...
A-01		Rind	Kombinations-Garvorgang "Grill" - C3
A-02		Schwein	Kombinations-Garvorgang "Grill" - C3
A-03		Geflügel	Kombinations-Garvorgang "Grill" - C3
A-04		Fisch	Kombinations-Garvorgang "Grill" - C3
A-05		Pizza	Automatikmenü "Pizza" - P2

A-06		Obst/ Gemüse	Mikrowellenbe- trieb mit 900 W Leistung
A-07		Kartoffeln	Mikrowellenbe- trieb mit 900 W Leistung
A-08		Aufwärmen	Mikrowellenbe- trieb mit 900 W Leistung
A-09		Getränke	Mikrowellenbe- trieb mit 900 W Leistung
A-10		Vorspeise	Mikrowellenbe- trieb mit 900 W Leistung
A-11		Auftauen nach Ge- wicht	Mikrowellenbe- trieb mit 100 W Leistung
A-12		Auftauen nach Zeit	Mikrowellenbe- trieb mit 100 W Leistung

### **Verletzungsgefahr!**







Der Drehteller  ist nach einem Garvorgang mit Grill sehr heiß! Benutzen Sie daher unbedingt Topflappen oder hitzebeständige Handschuhe wenn Sie ihn aus dem Garraum entnehmen.



### **Hinweis**

Bitte beachten Sie, dass Größe, Form und die Sorten der Lebensmittel das Kochergebnis mitbestimmen.

### **Anwendungsbeispiel 1:**









Gehen Sie wie folgt vor, wenn Sie 400 g Gemüse oder Obst garen wollen:

1. Drehen Sie den Drehregler   (im Stand-by-Betrieb) langsam nach links, bis „A-06“ im Display  erscheint und bestätigen Sie die Auswahl durch Drücken der Taste Start/Schnellstart  .
2. Stellen Sie mit dem Drehregler   das Gewicht „400“ ein.

3. Drücken Sie die Taste Start/Schnellstart  , um den Garvorgang zu starten.







### **Anwendungsbeispiel 2:**

Gehen Sie wie folgt vor, wenn Sie 300 ml Wasser erhitzen wollen:

1. Drehen Sie den Drehregler   (im Stand-by-Betrieb) langsam nach links, bis „A-09“ im Display  erscheint und bestätigen Sie die Auswahl durch Drücken der Taste Start/Schnellstart  .
2. Stellen Sie mit dem Drehregler   „300“ ein.
3. Drücken Sie die Taste Start/Schnellstart  , um den Garvorgang zu starten.







### **Anwendungsbeispiel 3:**

Gehen Sie wie folgt vor, wenn Sie 300 g Vorspeise erhitzen wollen:

1. Drehen Sie den Drehregler   (im Stand-by-Betrieb) langsam nach links, bis „A-10“ im Display  erscheint und bestätigen Sie die Auswahl durch Drücken der Taste Start/Schnellstart  .
2. Da „300“ als erste Auswahl im Display erscheint, drücken Sie die Taste Start/Schnellstart  , um den Garvorgang zu starten.

### **Pizza backen**

Mit dem Automatik-Programm „Pizza“ können Sie knusprige Pizza in der Mikrowelle zubereiten. Hierbei haben Sie die Auswahl zwischen den Pizza-Programmen „P-01“ (tiefgefrorene Pizza), „P-02“ (gekühlte Pizza) und „P-03“ (frische Pizza).

1. Drehen Sie den Drehregler   (im Stand-by-Betrieb) langsam nach links, bis „A-05“ im Display  erscheint.
2. Drücken Sie die Taste Start/Schnellstart  .
3. Wählen Sie mit Hilfe des Drehreglers   das passende Pizza-Programm:





# Auftauen

## Auftauen nach Gewicht







### Hinweis



Legen Sie die aufzutauenden Lebensmittel immer auf für Mikrowellen geeignetes Geschirr. Niemals direkt auf den Drehteller .









Mit dieser Funktion können Sie problemlos Fleisch, Geflügel, Fisch, Obst/Gemüse und Pizza auftauen. Die Auftauzeit und die Leistungsstufe werden nach Eingabe des Gewichts automatisch errechnet und eingestellt.

1. Drehen Sie im Standby-Modus den Drehregler  gegen den Uhrzeigersinn, bis im Display  „A-11“ erscheint und  blinkt (siehe Kapitel „Automatik-Menü“).
2. Drücken Sie die Taste Start/Schnellstart .
3. Wählen Sie nun durch Drehen des Drehreglers  das aufzutauende Lebensmittel.

Im Display  erscheint:

- „d-01“ und  für „Rind“
- „d-02“ und  für „Schwein“
- „d-03“ und  für „Geflügel“
- „d-04“ und  für „Fisch“
- „d-05“ und  für „Pizza“
- „d-06“ und  für „Obst/Gemüse“
- „d-07“ und  für „Kartoffeln“

4. Wenn das gewünschte Lebensmittel im Display  erscheint, drücken Sie die Taste Start/Schnellstart .
5. Stellen Sie durch Drehen des Drehreglers  das Gewicht ein.









- „P-01“ für tiefgefrorene Pizza, Temperatur ca. -18 Grad Gewicht 150 g – 450 g („P-01“ erscheint im Display .
  - „P-02“ für gekühlte Pizza, Temperatur ca. 5 Grad, Gewicht 150 g – 450 g („P-02“ erscheint im Display .
  - „P-03“ für frische Pizza, Temperatur ca. 20 Grad, Gewicht 150 g – 450 g („P-03“ erscheint im Display .
4. Bestätigen Sie Ihre Auswahl durch Drücken der Taste Start/Schnellstart  .
  5. Wählen Sie nun das gewünschte Gewicht mit dem Drehregler  und bestätigen Sie dieses durch Drücken der Taste Start/Schnellstart  . Der Garvorgang startet.

### Hinweis

Wenn Sie Pizza zubereiten, können Sie diese direkt auf den Drehteller  legen. So wird sie besonders knusprig. Achten Sie darauf, dass der Rand der Pizza während des Garvorganges nicht bis an die Wände des Garraumes ragt.

### Anwendungsbeispiel:

Gehen Sie wie folgt vor, wenn Sie eine tiefgefrorene, 450 g schwere Pizza garen wollen:

1. Drehen Sie den Drehregler  (im Standby-Betrieb) langsam nach links, bis „A-05“ im Display  erscheint.
2. Drücken Sie die Taste Start/Schnellstart .
3. Wählen Sie mit Hilfe des Drehreglers  das Programm „P-01“.
4. Drücken Sie die Taste Start/Schnellstart .
5. Wählen Sie mit dem Drehregler  das Gewicht „450“.
6. Drücken Sie die Taste Start/Schnellstart  , um den Garvorgang zu starten. Das Gerät errechnet automatisch die benötigte Zeit.

Es lassen sich folgende Gewichte einstellen:

„d-01“ /  / „Rind“ 100 - 1800g

„d-02“ /  / „Schwein“ 100 - 1800g

„d-03“ /  / „Geflügel“ 100 - 1800g

„d-04“ /  / „Fisch“ 100 - 1800g

„d-05“ /  / „Pizza“ 100 - 900g

„d-06“ /  / „Obst/Gemüse“ 100 - 900g

„d-07“ /  / „Kartoffeln“ 100 - 900g

5. Wenn das gewünschte Gewicht im Display **1** erscheint, drücken sie die Taste Start/Schnellstart **14** . Das Gerät errechnet die benötigte Auftauzeit automatisch.

### **Hinweis**





Um ein optimales Auftauen zu gewährleisten, ist es nötig die Speisen während des Auftauvorganges zu wenden. Das Gerät erinnert Sie an das Wenden, indem Signaltöne erklingen und auf dem Display **1** „turn“ erscheint. Öffnen Sie die Gerätetür, wenden Sie die Speise und schließen Sie die Gerätetür wieder. Drücken Sie die Taste Start/Schnellstart **14** , um den Auftauvorgang fortzuführen.

Wenn Sie die Speisen nicht wenden wollen, warten Sie nach den Signaltönen einfach ab. Das Gerät setzt den Auftauvorgang automatisch fort. Wir empfehlen das Wenden der Speisen. Damit erreichen Sie ein gleichmäßiges Auftauen.

## Auftauen nach Zeit

### **Hinweis**

Legen Sie die aufzutauenden Lebensmittel immer auf für Mikrowellen geeignetes Geschirr. Niemals direkt auf den Drehteller **3**!

1. Drehen Sie im Standby-Modus den Drehregler **14**  gegen den Uhrzeigersinn, bis im Display **1** „A-12“ und  erscheint.
2. Drücken Sie die Taste Start/Schnellstart **14** .
3. Stellen Sie die gewünschte Zeit mit dem Drehregler **14**  ein.
4. Drücken Sie die Taste Start/Schnellstart **14** , um den Auftauvorgang zu starten. Die Zeit zählt rückwärts herunter.

### **Hinweis:**

Um ein optimales Auftauen zu gewährleisten, ist es nötig die Speisen während des Auftauvorganges zu wenden. Das Gerät erinnert Sie an das Wenden, indem Signaltöne erklingen und auf dem Display **1** „turn“ erscheint. Öffnen Sie die Gerätetür, wenden Sie die Speise und schließen Sie die Gerätetür wieder. Drücken Sie die Taste Start/Schnellstart **14** , um den Auftauvorgang fortzuführen.

Wenn Sie die Speisen nicht wenden wollen, warten Sie nach den Signaltönen einfach ab. Das Gerät setzt den Auftauvorgang automatisch fort. Wir empfehlen das Wenden der Speisen. Damit erreichen Sie ein gleichmäßiges Auftauen.

# Rezepte

---

## Frikadellen

- Formen Sie je ca. 125g Rinderhackfleisch zu einer Frikadelle (Durchmesser ca. 75mm, Höhe ca. 35mm).
- Verteilen Sie die Frikadellen gleichmäßig auf dem Drehteller ❸.

## Zubereitung

Das beste Ergebnis erzielen Sie wenn Sie Heißluft und Mikrowellen-Funktion abwechselnd benutzen. Warten Sie jeweils ab, bis der eingestellte Garvorgang beendet ist und stellen Sie den nächsten Vorgang ein.

1. Heißluft 200 °C, 4:00 Min.
2. Mikrowelle 900 W Leistung , 5:30 Min.
3. Heißluft 200 °C, 2:00 Min  
(je nach persönlichem Geschmack kann auch eine Zeit von bis zu 4:00 Min. möglich sein).

## Aufbacken von Tiefkühlfertigbrötchen

- Zum Aufbacken von Brötchen wählen Sie die Heißluftfunktion.
- Legen Sie 3-4 Brötchen auf den Drehteller ❸. Ein Vorheizen der Mikrowelle ist nicht erforderlich. Wählen Sie folgende Einstellung für den Backvorgang:
  - Heißluft 170 °C, Dauer: 12 Minuten

Wenn Sie direkt im Anschluss weitere Brötchen aufbacken möchten, verkürzen Sie die Zeit um ca. 1-2 Minuten, da das Gerät nun bereits vorgeheizt ist.

## Kartoffelgratin

### Zutaten

- 750 g festkochende geschälte Kartoffeln
  - 300 g Sahne
  - 100 g geriebener Käse mit einem Fettgehalt von 25% bis 30 % Fett i. Tr.
  - Gewürze je nach Geschmack (z.B. Salz/Pfeffer)
- Benutzen Sie ein mikrowellenfestes, rundes Geschirr mit Deckel, mit einer Höhe von 5 bis 6 cm und einem Durchmesser von ca. 22 cm.

### Zubereitung

- Schneiden Sie die Kartoffeln in ca. 3 - 4 mm dicke Scheiben.
- Legen Sie ungefähr die Hälfte der Kartoffeln dachziegelartig in die Auflaufform.
- Bestreuen Sie die Kartoffeln mit ca. der Hälfte des Käses.
- Geben Sie die Hälfte der Gewürze hinzu sowie ca. 150 g Sahne.
- Legen Sie den Rest der geschnittenen Kartoffeln ebenfalls dachziegelartig darüber.
- Verteilen Sie den restlichen Käse über den Kartoffeln und schütten Sie die restliche Sahne darüber.
- Streuen Sie die restlichen Gewürze über das Gratin.
- Decken Sie das Geschirr mit dem Deckel ab und stellen Sie es mittig auf den Drehteller ❸.

### Zubereitung

Das beste Ergebnis erzielen Sie wenn Sie Heißluft und Mikrowellen-Funktion abwechselnd benutzen. Warten Sie jeweils ab, bis der eingestellte Garvorgang beendet ist und stellen Sie den nächsten Vorgang ein.

1. Mikrowelle 900 W Leistung, 10:00 Min.
2. Heißluft 200 °C, 13:00 Min.
3. Mikrowelle 900 W Leistung, 10:00 Min.

Ein Vorheizen ist nicht erforderlich.

## Muffins

### Zutaten

Das Rezept ergibt ca. 10 bis 20 Muffins.

- Backmargarine (80% Fettgehalt) oder gesalzene Butter
- 170 g Kristallzucker (max. Körnung 0,3 mm)
- 3 Eier (55 - 60 g mit Schale/Größe M)
- 225 g Weizenmehl
- 7 g Backpulver
- 0,25 g Salz

### Zubereitung

- Mischen Sie alle Zutaten gut durch.
- Füllen Sie den Muffinteig in handelsübliche Papier-Backförmchen (Durchmesser ca. 45 mm, Höhe ca. 28 mm)
- Heizen Sie die Mikrowelle mit der Heißluft-Funktion auf 170 °C vor.

### **Hinweis:**

*Sollten Sie bedingt durch die Anzahl der Muffins mehrere Backvorgänge benötigen, ist das Vorheizen nur einmal erforderlich.*

- Verteilen Sie nun die Muffins gleichmäßig auf dem Drehteller .
- Wählen Sie folgende Einstellung für den Backvorgang:  
Heißluft 170 °C, Dauer: 12 Minuten

## Reinigung und Pflege

---

### **Verletzungsgefahr!**

Schalten Sie vor dem Säubern die Mikrowelle ab und ziehen Sie den Netzstecker aus der Netzsteckdose. Ansonsten besteht die Gefahr eines elektrischen Schlages!



Auf keinen Fall darf das Gerät in Wasser oder andere Flüssigkeiten getaucht werden. Hierdurch kann Lebensgefahr durch elektrischen Schlag entstehen und das Gerät kann beschädigt werden.

- Halten Sie das Innere der Mikrowelle stets sauber.
- Sollten Speisespritzer oder verschüttete Flüssigkeiten an den Wänden der Mikrowelle haften, wischen Sie diese mit einem feuchten Tuch ab.
- Verwenden Sie ein mildes Spülmittel, sollte die Mikrowelle stärkere Verschmutzungen aufweisen.
- Vermeiden Sie die Benutzung von Reinigungssprays und anderen scharfen Putzmitteln, da diese Flecken, Streifen oder eine Trübung der Türoberfläche hervorrufen können.
- Säubern Sie die Außenwände mit einem feuchten Tuch.
- Um eine Beschädigung der Funktionsteile im Innern der Mikrowelle zu vermeiden, lassen Sie kein Wasser in die Lüftungsschlitze  einsickern.
- Entfernen Sie regelmäßig Spritzer oder Verunreinigungen. Reinigen Sie Tür, Sichtfenster beidseitig, Türdichtungen und benachbarte Teile mit einem feuchten Tuch. Verwenden Sie keine Scheuermittel.

- Sollte sich in oder um die Außenseite der Tür Dunst ablagern, wischen Sie ihn mit einem weichen Tuch ab. Hierzu kommt es, wenn die Mikrowelle unter hohen Feuchtigkeitsbedingungen betrieben wird.
- Reinigen Sie auch den Drehteller **3** regelmäßig. Spülen Sie ihn in warmer Seifenlauge.
- Reinigen Sie den Grillständer **15** in warmen Spülwasser und trocknen Sie ihn gut ab.
- Beseitigen Sie regelmäßig Gerüche. Stellen Sie eine tiefe Mikrowellenschüssel mit einer Tasse Wasser, Saft und Haut einer Zitrone gefüllt in die Mikrowelle. Erhitzen Sie diese für 5 Minuten. Gründlich abwischen und mit einem weichen Lappen trockenreiben.
- Sollte ein Auswechseln der Lampe in der Mikrowelle erforderlich werden, lassen Sie diese bitte von einem Händler ersetzen oder fragen Sie unseren Service.

## Fehlerbehebung

---

### Das Display **1** zeigt nichts an.

- Der Netzstecker steckt nicht in der Netzsteckdose. Kontrollieren Sie den Netzstecker.
- Die Netzsteckdose ist defekt. Probieren Sie eine andere Netzsteckdose.
- Das Display **1** ist defekt. Kontaktieren Sie den Service.

### Das Gerät reagiert nicht auf das Drücken der Tasten.

- Die Kindersicherung ist aktiviert. Deaktivieren Sie die Kindersicherung (siehe Kapitel „Bedienen“).

### Das Gerät startet den Gar-/Kochvorgang nicht.

- Die Tür ist nicht richtig verschlossen. Schließen Sie die Tür richtig.

### Der Drehteller **3** erzeugt beim Drehen laute Geräusche.

- Der Drehteller **3** liegt nicht richtig auf der Achse. Legen Sie den Drehteller **3** korrekt in den Garraum ein.
- Die kleinen Rollen **4** und/oder der Boden des Garraumes sind verschmutzt. Reinigen Sie die Rollen **4** und den Boden.

### Das Display **1** zeigt „E01“ an und Signaltöne erklingen.

- Die Mikrowelle ist überhitzt. Brechen Sie sofort das laufende Programm ab. Ziehen Sie den Netzstecker, öffnen Sie die Mikrowellentür und lassen Sie das Gerät abkühlen.

### Das Display **1** zeigt „E02“ an und Signaltöne erklingen.

- Es liegt ein Fehler am Sensor vor. Unterbrechen Sie das Programm und lassen Sie das Gerät abkühlen. Starten Sie dann die Mikrowelle erneut. Sollte der Fehler wiederholt auftreten, wenden Sie sich an den Kundendienst.
- Es liegt ein Fehler beim Aufheizen des Gerätes vor. Unterbrechen Sie das Programm und lassen Sie das Gerät abkühlen. Starten Sie dann die Mikrowelle erneut. Sollte der Fehler wiederholt auftreten, wenden Sie sich an den Kundendienst.

### Das Display **1** zeigt „E03“ an und Signaltöne erklingen.

- Die Mikrowelle ist, aufgrund eines Kurzschlusses oder einer Leerlaufspannung, in den Fehlfunktion-Schutz gewechselt. Unterbrechen Sie das Programm und ziehen Sie den Netzstecker. Beheben Sie, falls möglich das Problem, z.B. Metall im Garraum, welches bei Nutzung der Mikrowellenfunktion zu oben genannten Problem führen kann. Ansonsten wenden Sie sich bitte an den Kundendienst.



## Entsorgen

---



**Werfen Sie das Gerät keinesfalls in den normalen Hausmüll. Dieses Produkt unterliegt der europäischen Richtlinie 2012/19/EU.**

Entsorgen Sie das Gerät über einen zugelassenen Entsorgungsbetrieb oder über Ihre kommunale Entsorgungseinrichtung.

Beachten Sie die aktuell geltenden Vorschriften. Setzen Sie sich im Zweifelsfall mit Ihrer Entsorgungseinrichtung in Verbindung.



Führen Sie alle Verpackungsmaterialien einer umweltgerechten Entsorgung zu.

## Garantie und Service

---

Sie erhalten auf dieses Gerät 3 Jahre Garantie ab Kaufdatum. Das Gerät wurde sorgfältig produziert und vor Anlieferung gewissenhaft geprüft.

Bitte bewahren Sie den Kassenbon als Nachweis für den Kauf auf. Bitte setzen Sie sich im Garantiefall mit Ihrer Servicestelle telefonisch in Verbindung. Nur so kann eine kostenlose Einsendung Ihrer Ware gewährleistet werden.

Die Garantieleistung gilt nur für Material- oder Fabrikationsfehler, nicht aber für Transportschäden, Verschleißteile oder für Beschädigungen an zerbrechlichen Teilen, z. B. Schalter oder Akkus. Das Produkt ist lediglich für den privaten und nicht für den gewerblichen Gebrauch bestimmt.

Bei missbräuchlicher und unsachgemäßer Behandlung, Gewaltanwendung und bei Eingriffen, die nicht von unserer autorisierten Service-Niederlassung vorgenommen wurden, erlischt die Garantie. Ihre gesetzlichen Rechte werden durch diese Garantie nicht eingeschränkt.

Die Garantiezeit wird durch die Gewährleistung nicht verlängert. Dies gilt auch für ersetzte und reparierte Teile. Eventuell schon beim Kauf vorhandene Schäden und Mängel müssen sofort nach dem Auspacken gemeldet werden, spätestens aber zwei Tage nach Kaufdatum. Nach Ablauf der Garantiezeit anfallende Reparaturen sind kostenpflichtig.

### **DE Service Deutschland**

Tel.: 0800 5435 111

(Kostenfrei aus dem dt. Festnetz/Mobilfunknetz)

E-Mail: [kompernass@lidl.de](mailto:kompernass@lidl.de)

**IAN 96324**

### **AT Service Österreich**

Tel.: 0820 201 222 (0,15 EUR/Min.)

E-Mail: [kompernass@lidl.at](mailto:kompernass@lidl.at)

**IAN 96324**

### **CH Service Schweiz**

Tel.: 0842 665566 (0,08 CHF/Min.,  
Mobilfunk max. 0,40 CHF/Min.)

E-Mail: [kompernass@lidl.ch](mailto:kompernass@lidl.ch)

**IAN 96324**

### **Erreichbarkeit Hotline:**

Montag bis Freitag von 8:00 Uhr - 20:00 Uhr (MEZ)

## Importeur

---

KOMPERNASS HANDELS GMBH  
BURGSTRASSE 21  
44867 BOCHUM  
GERMANY  
[www.kompernass.com](http://www.kompernass.com)

**KOMPERNASS HANDELS GMBH**

BURGSTRASSE 21

44867 BOCHUM

DEUTSCHLAND / GERMANY

[www.kompernass.com](http://www.kompernass.com)

Versione delle informazioni · Last Information Update

Stand der Informationen:

02 / 2014 · Ident.-No.: SMW900EDSB2-012014-1

IAN 96324